

NOTES:

ELECTRICAL:

- 1. Contact Resistance : 20MΩ MAX
- 2. Insulation Resistance : 500MΩ MIN @ 500V DC
- 3. Withstand Voltage : DC1000V AC700V RMS 60Hz, 1MIN

ENVIRONMENTAL:

- 1. Storage : -40° TO+70°
- 2. Operation : -10° to+60°

MECHANICAL

- 1. SHIELD MATERIAL: ZINC ALLOY
- 2. IDC MATERIAL: PC UL94V2 TERMINAL:PHOSPHOR BRONZE, TIN PLATING
- 3. IDC Life : 250 Times Min
- 4. Support PoE per IEEE 802.3af, PoE+ per IEEE 802.3at
- 5. RJ45 Contacts durability:750 cycles min
- 6. For cable AWG 23/1-26/1(1/0.40-1/0.58mm)
- 7. For cable OD:5.5-9.0mm

ISO/IEC 11801-1

EIA/TIA 568-C

IEC 60603-7-51

RoHS 2.0 and REACH Compliant

Accessories

▪Cable Tie(75X1.9mm) *1Pc

▪Copper foil*1Pc

Function test: AEM MMVAN-200+VNA Manager TEST

Website: <https://aem-test.com/>

(Random test 0.3%)

SinglePack: 1pc/PE bag+label; SubPack: 25pcs/box+label; Carton +labelx2;

MATERIAL LIST:

⑦	MODULAR COVER	PC UL94V2	1	
⑥	RJ 45 JACK INSERT	8P8C GOLD PLATED	8	
⑤	PCB	1.0mm UL 94V0	1	
④	IDC BODY	PC UL 94V2	1	
③	IDC PIN	PHOSPHOR BRONZE & TINNED	8	
②	LABEL COLOR CODE	T568A/B	2	
①	IDC TERMINAL	FOR 23-26AWG CABLE	1	
NO.	PARTS NAME	SPECIFICATION STANDARD	QT' Y	REMARK

SYNERGY21

					CUSTOMER		ITEM NO.		S216379		
					PRODUCT NAME		manufacture country:		CHINA	UNIT	MM
					Components Cat.6A Keystone Jack 180 degree Slim Type						
NEW			2021-11-16	A0	DRAWNBY	CHECKBY	APPOBY	DATE			
BY	CHK	REVISION RECORD MODIFICATIONS	DATE	REV.	SYNERGY21	SYNERGY21	SYNERGY21	2021-11-16			

Installationsanleitung/Installation guide

Super slim Cat.6A Keystone Jack

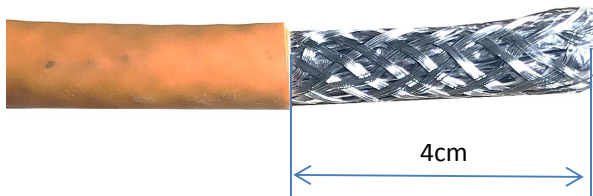

①.Stripping 4cm of sheath.



②.foldback braided and drained wire.

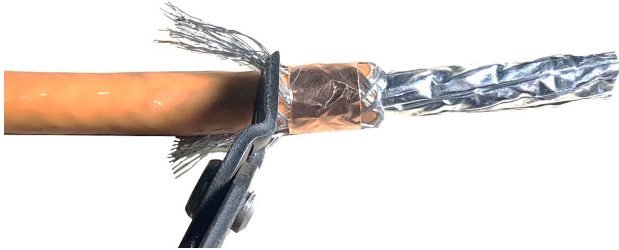

③.paste copper foil on the braided and ground wire and cut off the excess weave and the ground wire

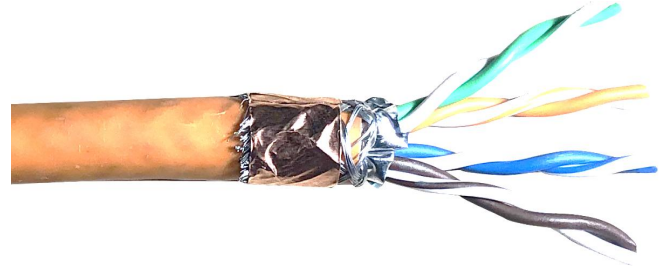

④.4.Fan out all four twisted pairs, allocate each by following colorcoding label

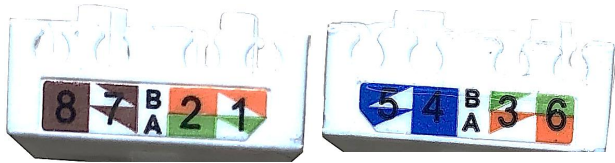

⑤.Across the holde by the color marks of T568A or T568B

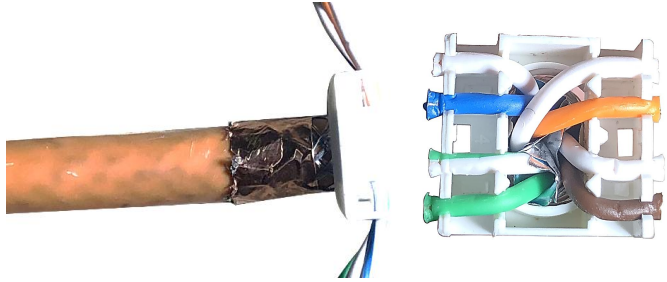

⑥. allocate each conductor into proper slots on wiring cap by following color coding



⑦.Trim the theends of conductors.

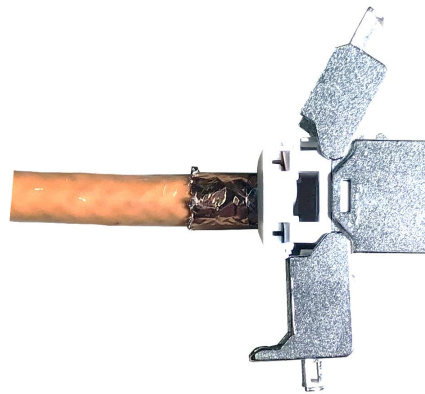

⑧.install the termination cap in direction of arrow into the keystone jack

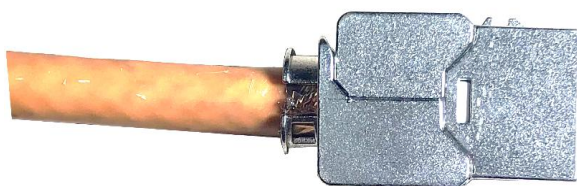

⑨.press both covers of the keystone jack to contact the cable

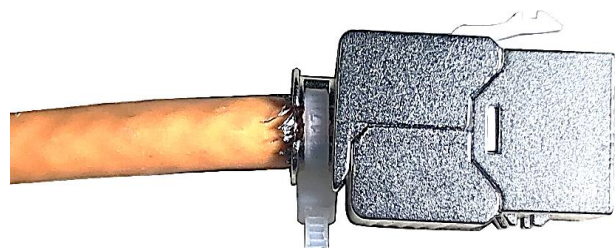

⑩.use cable tie for strain relief and to fix the shielding clamp

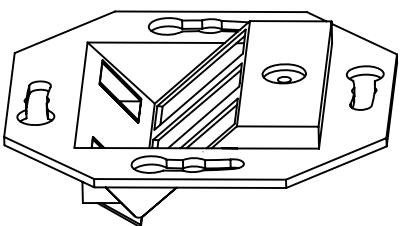
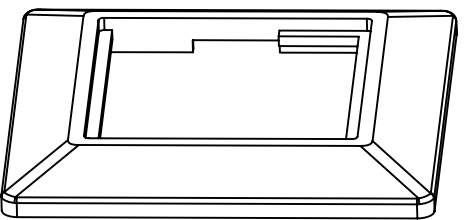
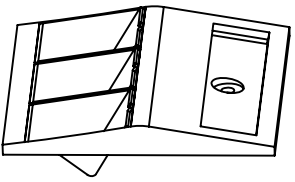

ITEM NO	COLOUR
S216327	pure white, RAL9010
S216326	pearl white, RAL1013

Chart:

Materials:

Outlet Housing: Fireproof ABS UL-94V0/Colour:see the chart
 Outlet Base:Fireproof ABS UL-94V0/Colour:see the chart
 Metallic Plate:Al&Zn Alloy /Al&Zn Alloy,
 ACCESSORY :
 1. Label
 2. Plastic gasket
 3. Screw:M4*9*2Pcs
 Apply to the keystone jack which the width less than 17.2mm
 RoHS Compliant
 Packing: 1pcs/PE bag+lable, 12pcs/box+lable, 120pcs/carton

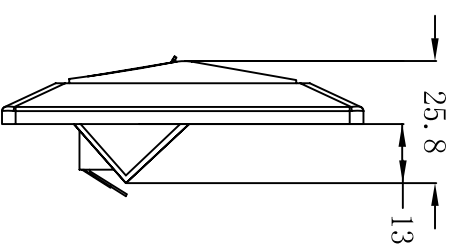
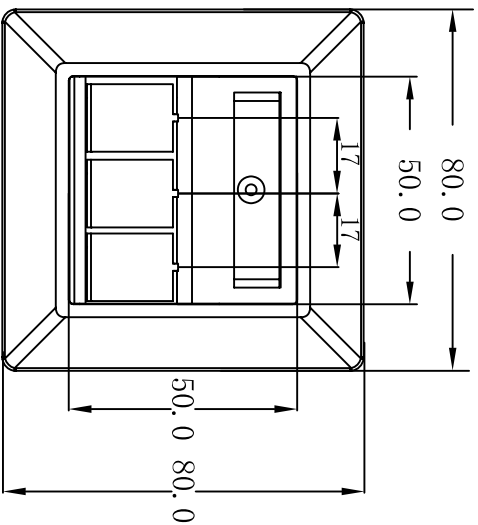

SYNERGY 21

CUSTOMER		ITEM NO.		see the chart	
PRODUCT NAME	FRAME SET 3PORT	manufacture country	China	UNIT	MM
NEW					
2011-07-11		A			
DATE	REV.	SYNERGY 21	SYNERGY 21	SYNERGY 21	2011-07-11

REVISION RECORD MODIFICATIONS

BY CHK

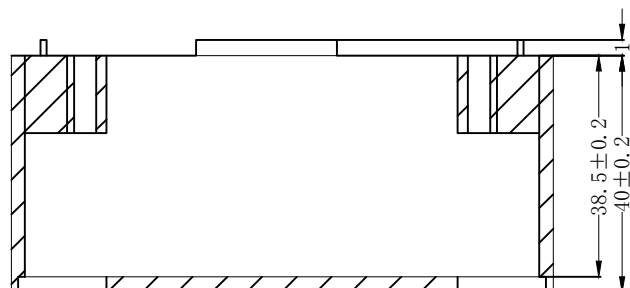
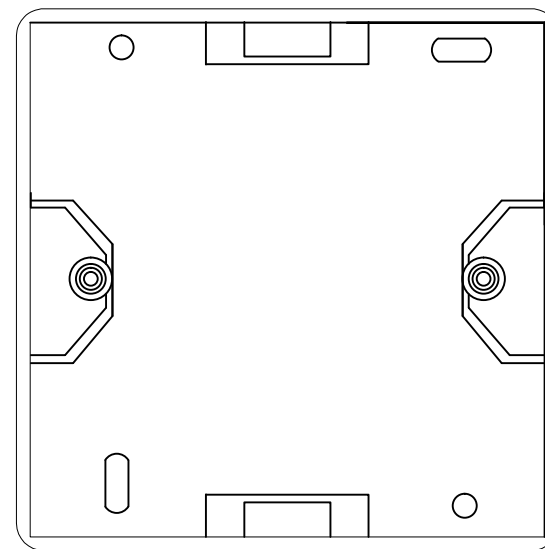
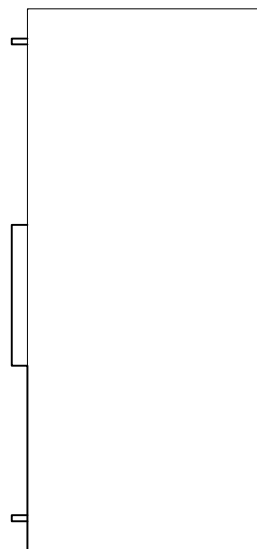
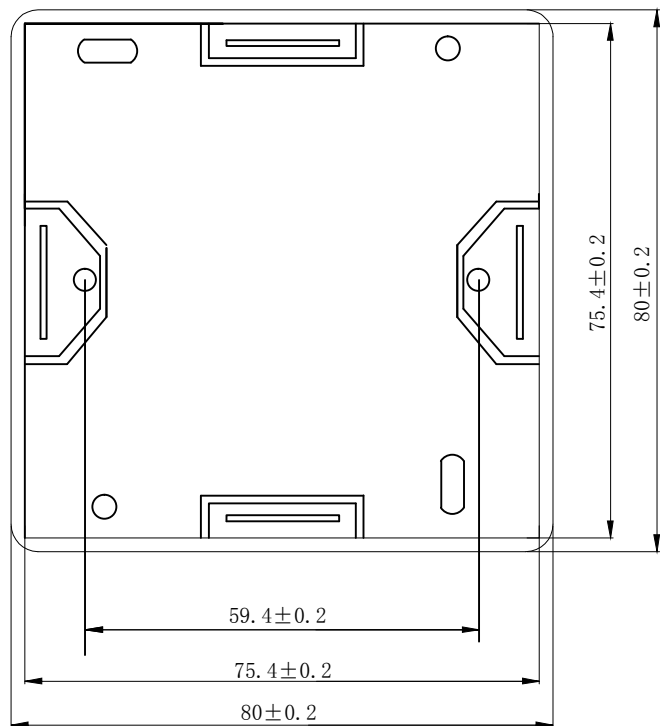

ITEM NO.	COLOUR
S216328	Pure White RAL9010
S216329	Pearl White RAL1013

NOTE:

MATERIAL: ABS

SIZE: 80MM*80MM*40MM

RoHS2.0 AND REACH COMPLIANT

ACCESSORY: SCREW M3*14 2PCS

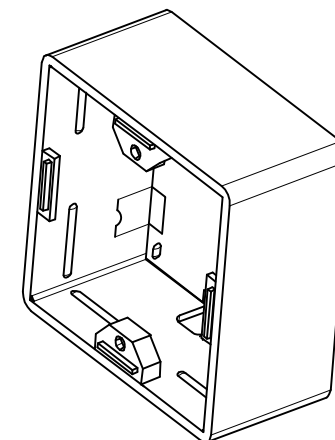

		UPDATE PACKING TYPE	2018-03-20	A3	SYNERGY 21					
		UPDATE PRODUCT	2014-09-24	A2	CUSTOMER		ITEM NO.	see the chart		
		UPDATE ROHS COMPLIANT	2013-07-10	A1	PRODUCT NAME	mounting box	manufacture country:	CHINA	UNIT	MM
		NEW	2011-07-11	A	DRAWNBY	CHECKBY	APPOBY	DATE		
BY	CHK	REVISION RECORD MODIFICATIONS	DATE	REV.	SYNERGY 21	SYNERGY 21	SYNERGY 21	2018-03-20		

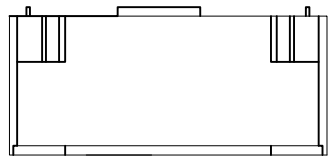

mounting box+pe bag

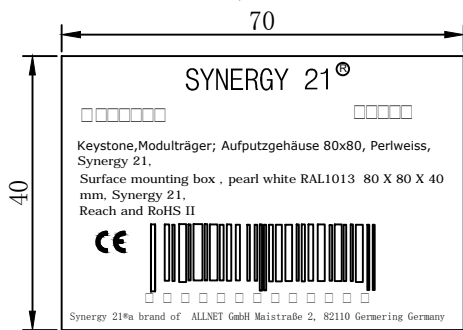
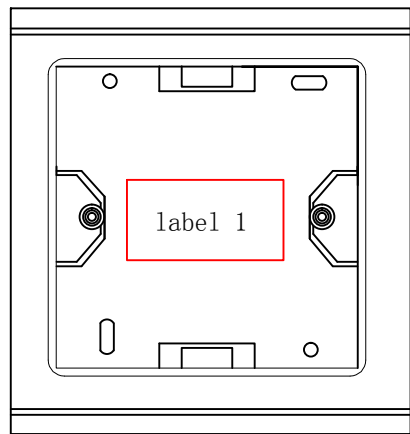

pe bag label

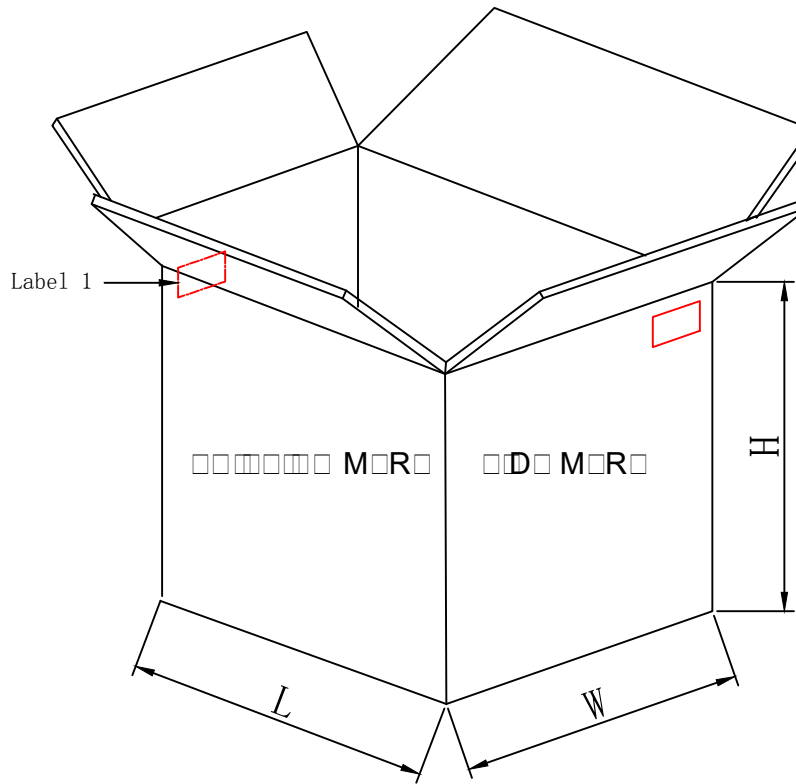
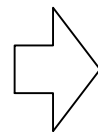

96PCS/CTN+LABEL 1

SHIPPING MARK



PO NO. :
REACH and ROHS 2.0 Compliant
MADE IN CHINA

SIDE MARK

PO NO. :
Item no:
Q' TY:
N. W
G. W
Carton no.
MEAS.

1. Packing: 1PCS/PE Bag A+Label 1, 96PCS/CTN+LABEL 1
2. “工” type sealing
3. “井” type packaging

SYNERGY 21

					CUSTOMER		ITEM NO.	see the chart		
		UPDATE PACKING TYPE	2018-03-20	A3	PRODUCT NAME	PACKING	manufacture country:	CHINA	UNIT	MM
		NEW			DRAWNBY	CHECKBY	APPOBY	DATE		
BY	CHK	REVISION RECORD MODIFICATIONS	DATE	REV.	SYNERGY 21	SYNERGY 21	SYNERGY 21	2018-03-20		