

# SYNERGY 21<sup>®</sup>

"SYNERGY 2<sup>®</sup>" for black printing The pantone of Color is grey  
 "1" for blue printing The pantone of Color is 298C

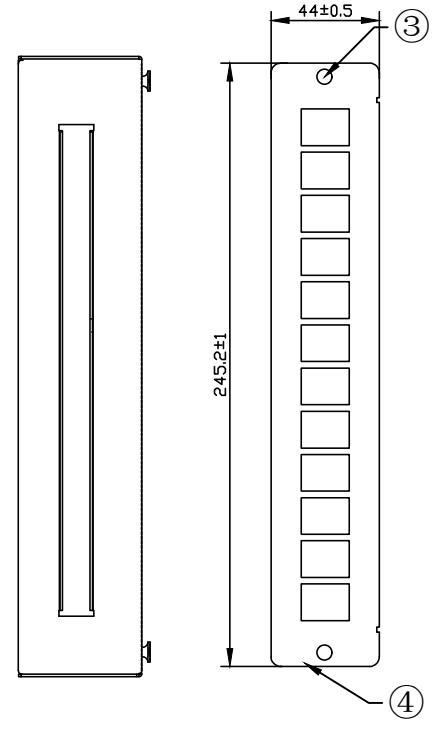
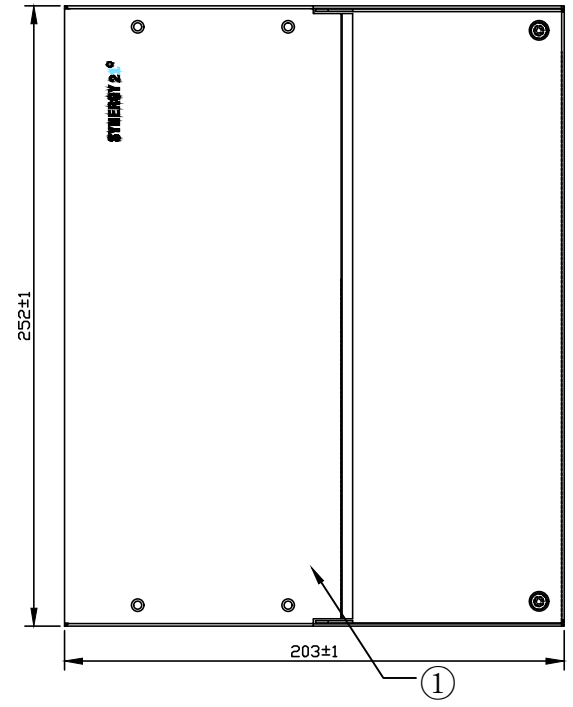
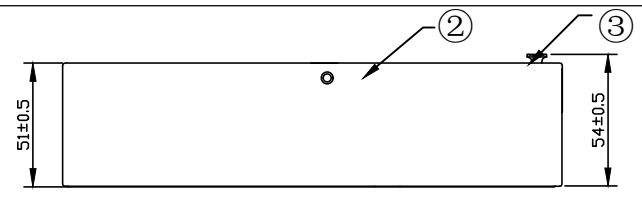

**NOTE:**

1. Suitable for copper and fiber optic technology
2. Expandable for installation on DIN rails with optional accessories (S216385)
3. Cable input and cable output with cable management and dust-proof foam
4. Protection type: IP20
5. RoHS3.0 AND REACH COMPLIANT
6. Storage temperature : -20°C+80°C
7. Operation temperature: -10°C+60°C
8. Packing:1pc/Box+label

**MATERIAL LIST:**

④	Panel	12port for RJ45 Keystone modules SPCC T=1.0MM with plastic powder cladding	1	
③	Push and pull buckle	BLACK	4	
②	Top Cover	SPCC T=1.0MM with plastic powder cladding	1	
①	Bottom Panel	SPCC T=1.0MM with plastic powder cladding	1	
NO.	PARTS NAME	SPECIFICATION DESCRIPTION	QT'Y	REMARK
		NEW	2023-03-27	A
BY	CHK	REVISION RECORD MODIFICATIONS	DATE	REV.

<b>SYNERGY21</b>					
CUSTOMER		ITEM NO.		S216384	
PRODUCT NAME		manufacture country:		CHINA	UNIT MM
Consolidation Point Box		APPOBY		DATE	
DRAWNBY		CHECKBY		DATE	
SYNERGY21		SYNERGY21		SYNERGY21 2023-03-27	

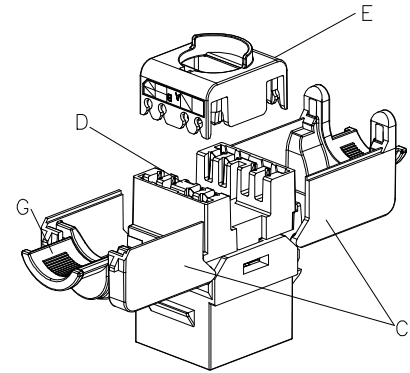
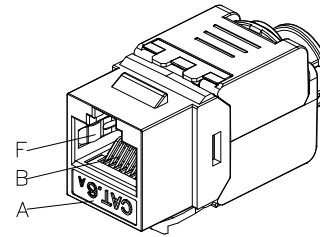
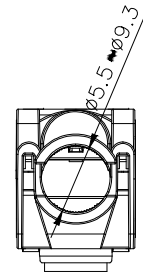
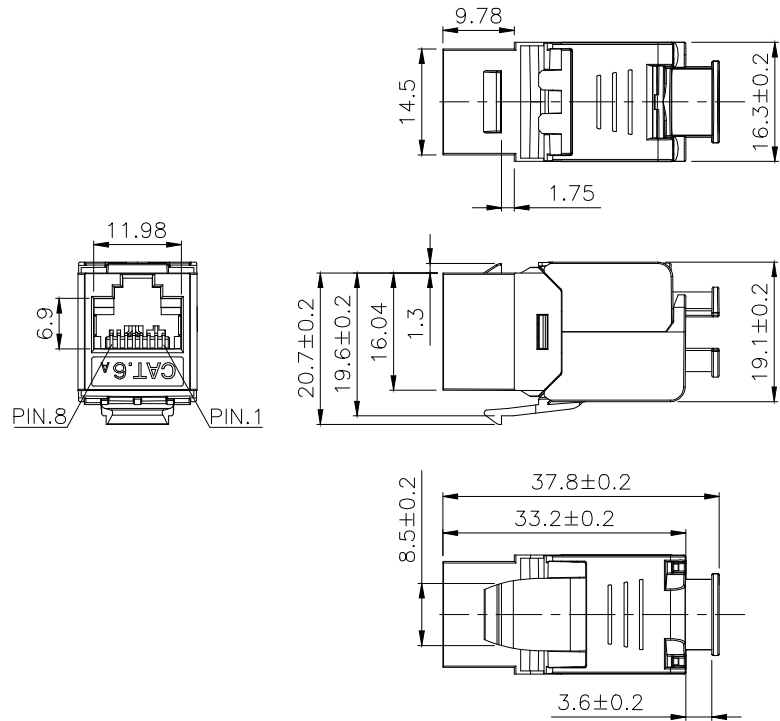

NOTES:

ELECTRICAL:

- 1. Contact Resistance : 20MΩ MAX
- 2. Insulation Resistance : 500MΩ MIN @ 500V DC
- 3. Withstand Voltage : DC1000V AC700V RMS 60Hz, 1MIN

ENVIRONMENTAL:

- 1. Storage : -40° TO+70°
- 2. Operation : -10° to+60°

MECHANICAL

- 1. SHIELD MATERIAL: ZINC ALLOY
- 2. IDC MATERIAL: PC UL94V2 TERMINAL:PHOSPHOR BRONZE, TIN PLATING
- 3. IDC Life : 250 Times Min
- 4. Support PoE per IEEE 802.3af, PoE+ per IEEE 802.3at
- 5. RJ45 Contacts durability:750 cycles min
- 6. For cable AWG 23/1-26/1(1/0.40-1/0.58mm)
- 7. For cable OD:5.5-9.0mm

ISO/IEC 11801-1

EIA/TIA 568-C

IEC 60603-7-51

RoHS 2.0 and REACH Compliant

Accessories

▪Cable Tie(75X1.9mm) \*1Pc

▪Copper foil\*1Pc

Function test: AEM MMVAN-200+VNA Manager TEST

Website: <https://aem-test.com/>

(Random test 0.3%)

SinglePack: 1pc/PE bag+label; SubPack: 25pcs/box+label; Carton +labelx2;

MATERIAL LIST:

⑦	MODULAR COVER	PC UL94V2	1	
⑥	RJ 45 JACK INSERT	8P8C GOLD PLATED	8	
⑤	PCB	1.0mm UL 94V0	1	
④	IDC BODY	PC UL 94V2	1	
③	IDC PIN	PHOSPHOR BRONZE & TINNED	8	
②	LABEL COLOR CODE	T568A/B	2	
①	IDC TERMINAL	FOR 23-26AWG CABLE	1	
NO.	PARTS NAME	SPECIFICATION STANDARD	QT' Y	REMARK

SYNERGY21

					CUSTOMER				ITEM NO.	S216379		
					PRODUCT NAME	Components Cat.6A Keystone Jack 180 degree Slim Type			manufacture country:	CHINA	UNIT	MM
					NEW	2021-11-16	A0	DRAWNBY	CHECKBY	APPOBY	DATE	
BY	CHK	REVISION RECORD MODIFICATIONS			DATE	REV.	SYNERGY21	SYNERGY21	SYNERGY21	2021-11-16		

# Installationsanleitung/Installation guide

## Super slim Cat.6A Keystone Jack

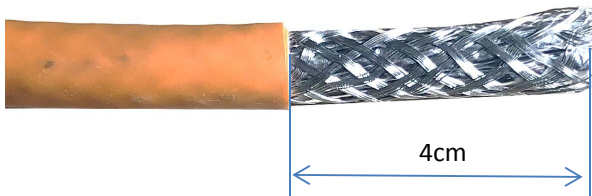

①.Stripping 4cm of sheath.

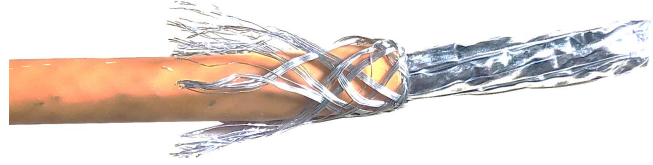

②.foldback braided and drained wire.

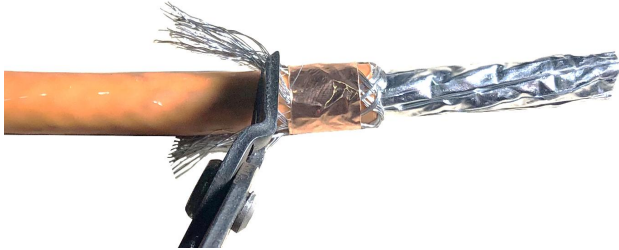

③.paste copper foil on the braided and ground wire and cut off the excess weave and the ground wire

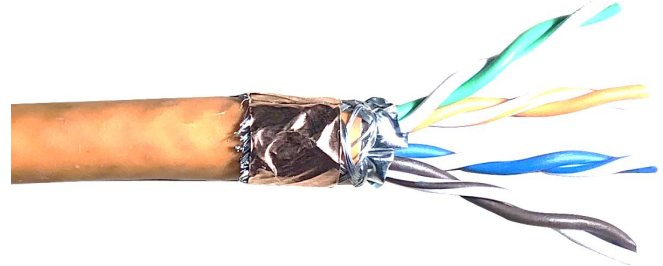

④.4.Fan out all four twisted pairs, allocate each by following colorcoding label

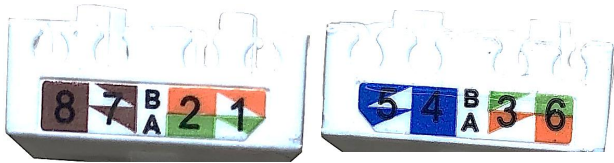

⑤.Across the holde by the color marks of T568A or T568B

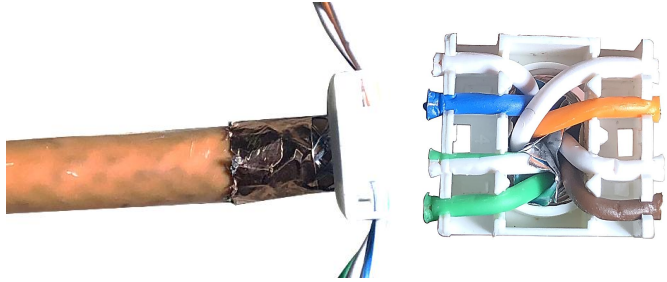

⑥. allocate each conductor into proper slots on wiring cap by following color coding



⑦.Trim the theends of conductors.

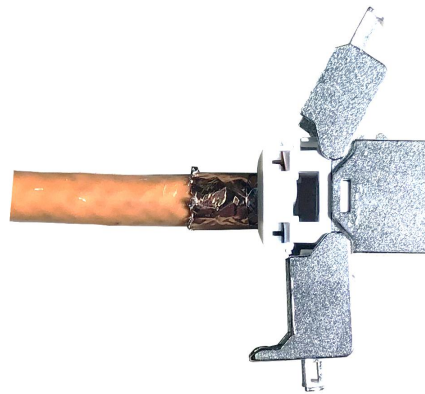

⑧.install the termination cap in direction of arrow into the keystone jack

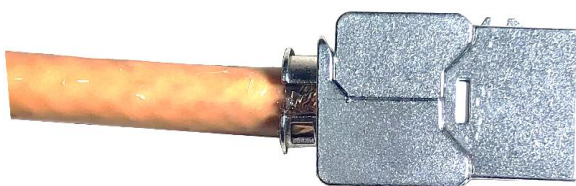

⑨.press both covers of the keystone jack to contact the cable

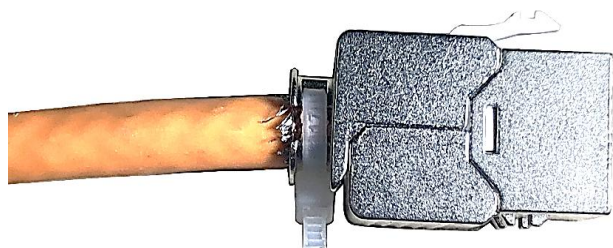

⑩.use cable tie for strain relief and to fix the shielding clamp