

VKA-2 Box

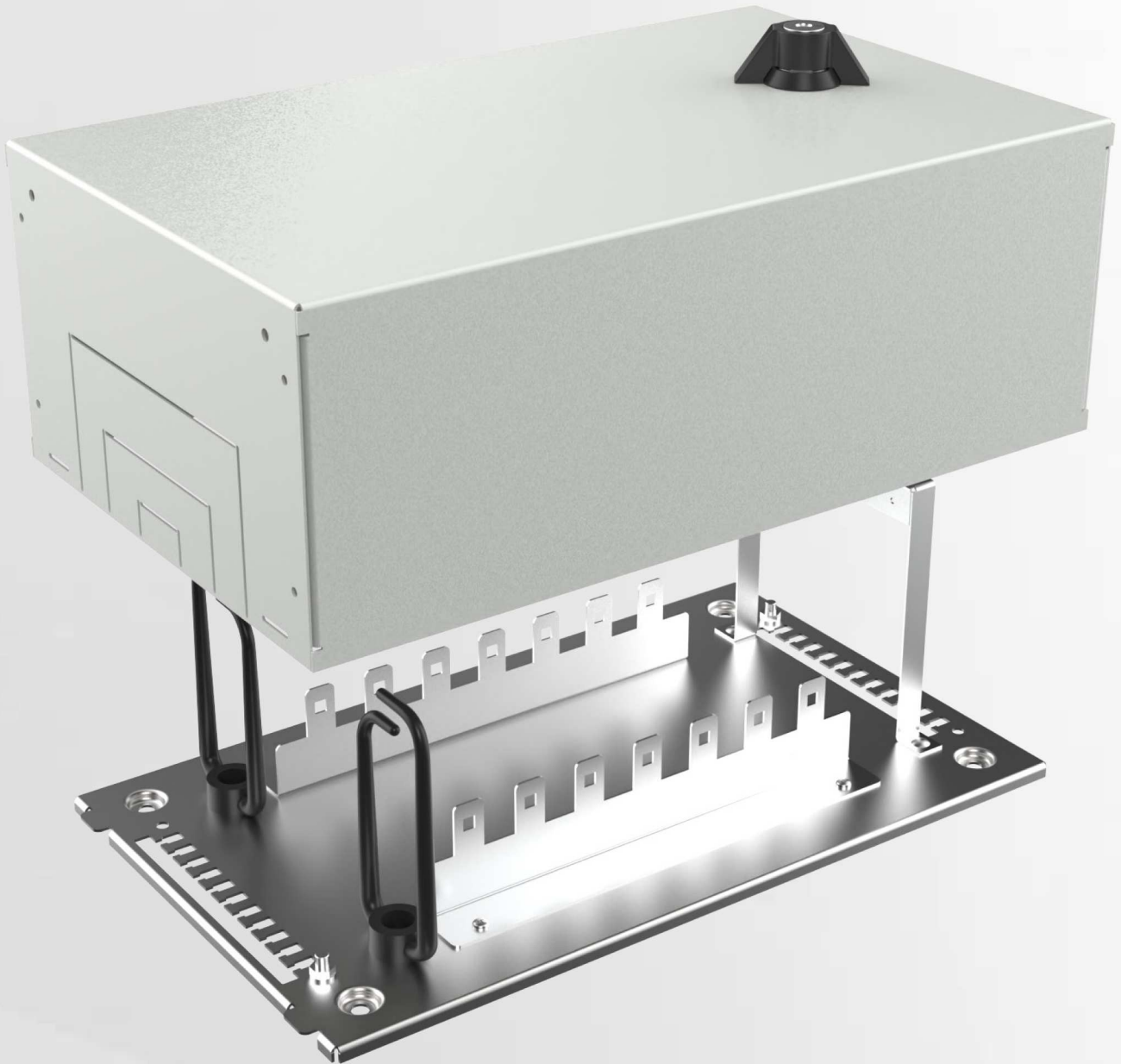

VKA-2 Box



Technical Details

Features

Top Cover
Tyre-Up
Butterfly Lock
Plastic Hook Organiser

Material

1-1.2 mm Steel

Dimensions

Width : 203 mm
Height : 334 mm
Depth : 120 mm

Appearance

Finish Surface : Powder Coating
Color : RAL7035

VKA-2 Box

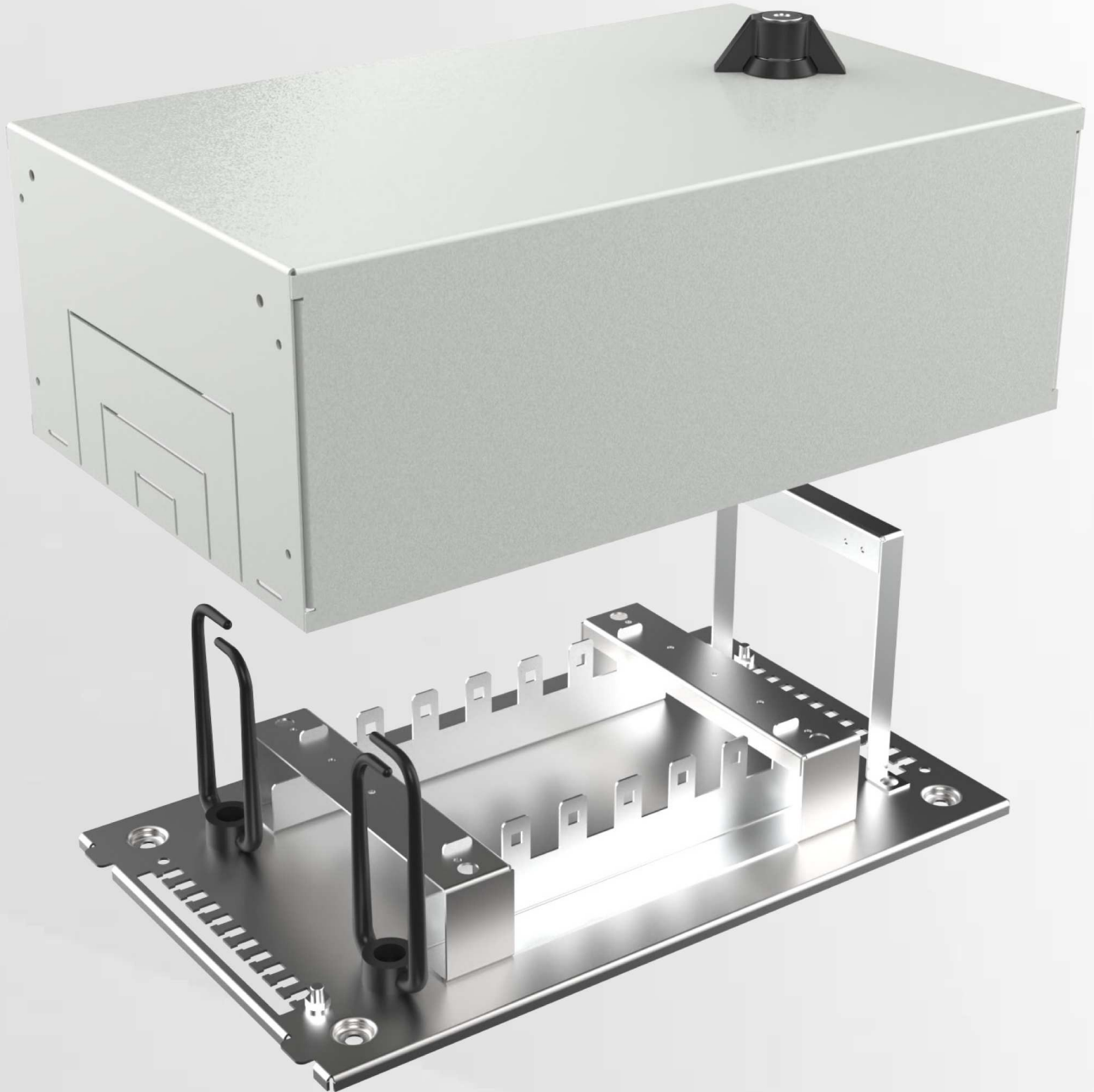

VKA 2 Box with Vertical Tyre-Up

VKA-2 Box

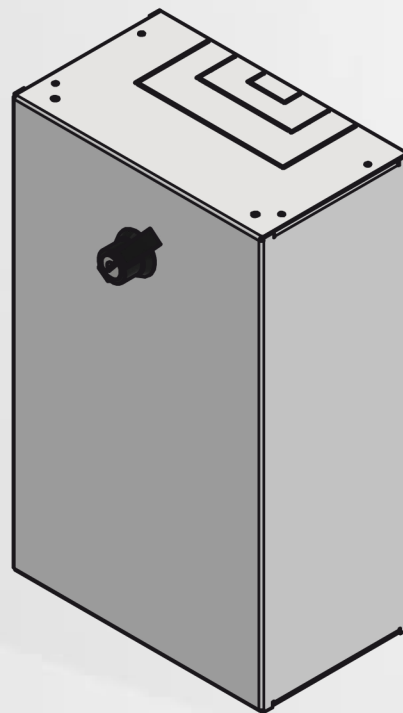
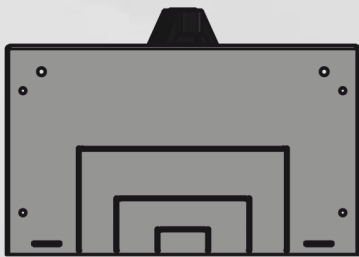
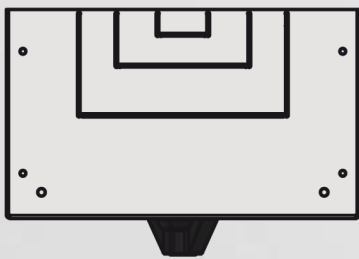
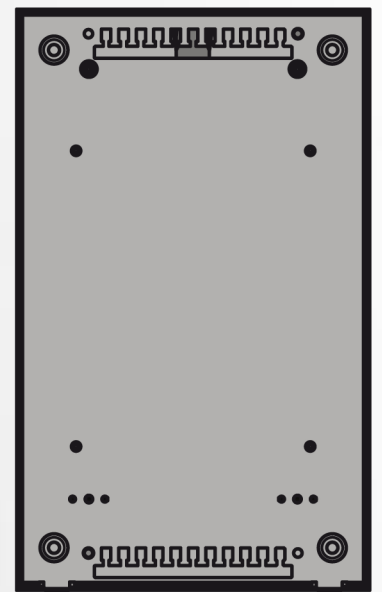
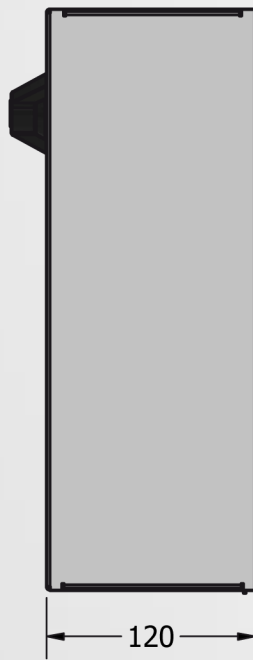
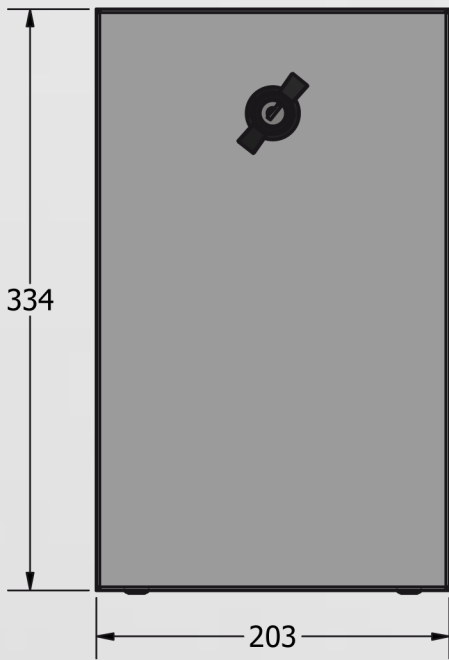

Bottom View

Front Isometric View

VKA-2 Box

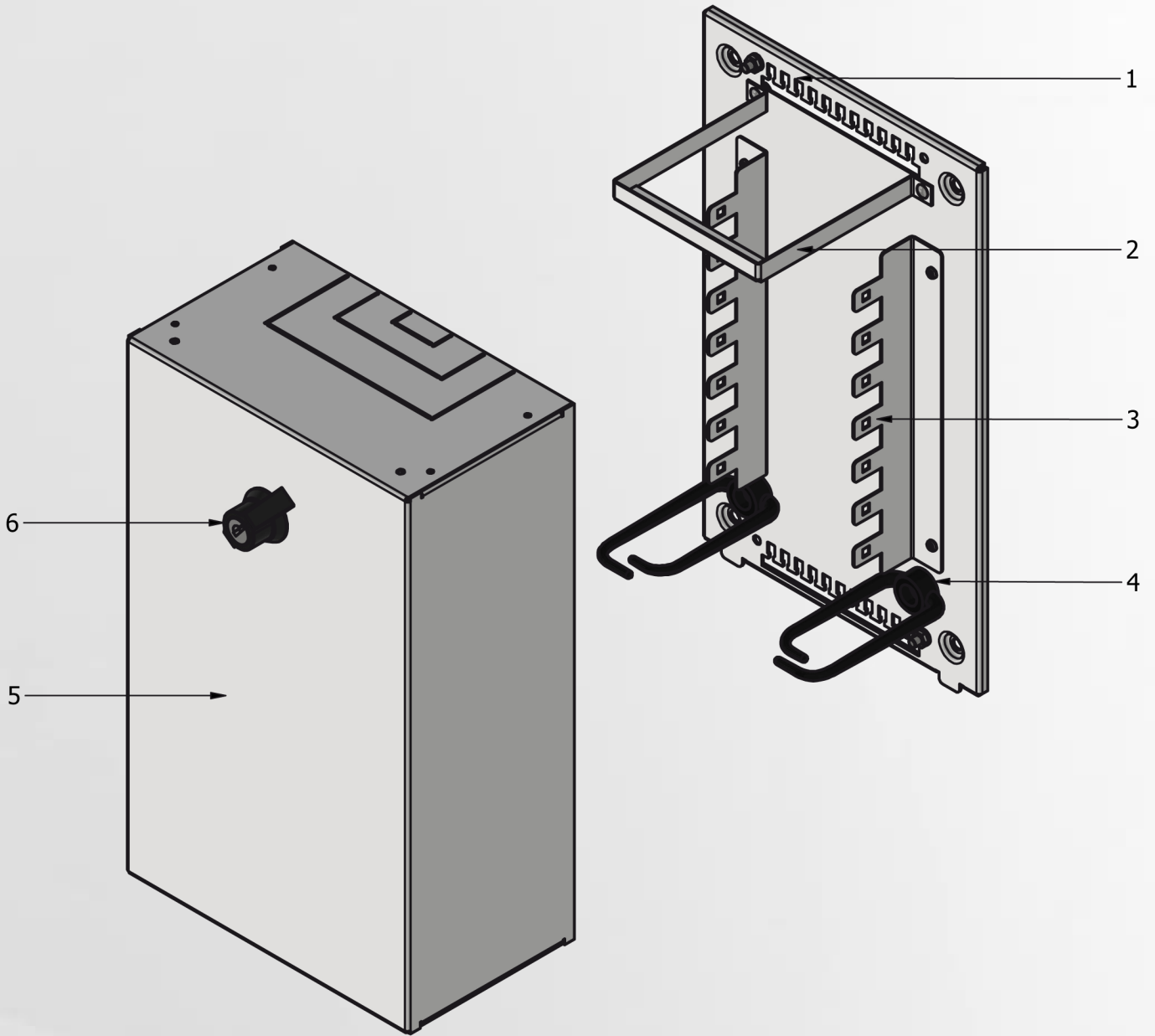

COMPONENT LIST

NO	PART NAME	NO	PART NAME
1	Inner Tray	4	Plastic Hook Organiser
2	L Bended Lock Holder	5	Outer Cover
3	Tyre-Up	6	Butterfly Lock