

Item No.	Description
S216823V2	50M
S216822V2	90M

MATERIAL LIST:

⑧	Cable	CAT7A S/FTP 23AWG 1200MHz BC Solid LSZH Cable Orange RAL 2003	1	
⑦	Snap ring	Plastic	1	
⑥	Brake pads	Plastic	1	
⑤	Handle	rubber	1	
④	Support shaft	Iron	1	
③	PLug	Cat 6A STP Field installable PLug	1	
②	FACE PLATE	86*86mm one-port, Title block with Transparent cover, Dust cap, RAL9010 with CAT6A STP keystone jack	1	
①	Plastic reel	φ335mm with face plate, Plastic	1	
NO.	PARTS NAME	SPECIFICATION STANDARD	QT' Y	REMARK

FLUKE MPTL LINK TEST:
TEST LIMIT: ISO11801 MPTL Class EA(+PoE)

- Notes:
1. ISO/IEC 11801:2002 Class Fa 1000MHz
 2. ISO/IEC EN 50173 Class Fa 1000MHz
 3. EIA/TIA 568-C 1000MHz
 4. IEC 60603-7-71
 5. RJ45 Contacts durability: 750 cycles min
 6. Support PoE, PoE+, PoE++
 7. Operating Temperature: -20~+75°C
 8. RoHS 3.0 and REACH Compliant

SYNERGY21

		CUSTOMER		AN		ITEM NO.									
		PRODUCT NAME		manufacture country:		CHINA		UNIT		MM					
		NEW		2022-07-15		A		DRAWNBY		CHECKBY		APPOBY		DATE	
BY		CHK		REVISION RECORD MODIFICATIONS		DATE		REV.		SYNERGY21		SYNERGY21		SYNERGY21 2022-07-15	

SPECIFICATIONS

TITLE: CAT. 7A S/FTP SOLID CABLE 23AWG (1/0.585 BC*1P+AL-FOIL) × 4PAIR+BRAID (0.12/6/16) AL-MG LSZH JACKET OD: 7.7 ± 0.2MM

FILE AMEND NOTE	DATE	EDITION
ORIGINALITY EDITION	2022-07-15	A/0

VIEW:

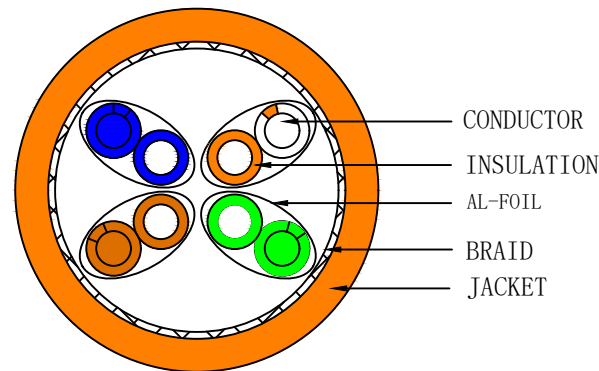

ITEMS		UNIT	A (4P)			
CONDUCTOR	SIZE	AWG	23AWG			
	CONSTRUCTION	PCS/mm	1/0.585 ± 0.008mm			
	MATERIAL	/	BC			
	PICKS	mm	/			
INSULATION	MATERIAL	/	Foam-PE			
	DIA.	mm	1.38 ± 0.05mm	1.38 ± 0.05mm	1.38 ± 0.05mm	1.38 ± 0.05mm
	COLOR	/	BLUE/WHITE-BLUE	ORANGE/WHITE-ORANGE	GREEN/WHITE-GREEN	BROWN/WHITE-BROWN
	CONCENTRIC	%	≥90%	≥90%	≥90%	≥90%
	NOM. THICKNESS	mm	0.40 ± 0.05MM			
TWIST	CONSTRUCTION	/	1P	1P	1P	1P
	AL-FOIL	mm u	YES			
	MYLAR	mm u	/			
	CONTORT	%	/	/	/	/
	OVERLAPPING	%	>25%	>25%	>25%	>25%
	DIA.	mm	/	/	/	/
	PICK	mm	/			
TWIST	CONSTRUCTION	/	4P			
	MYLAR OVERLAPPING	mm u %	/			
	DRAIN WIRE	mm	/			
	AL-FOIL/OVERLAPPING	mm u %	/			
	FILLERS	/	/			
	PE SKELETON	mm	/			
BRAID/SHIERLD	CONSTRUCTION	/	0.12/6/16 AL-MG OVERLAPPING ≥40%			
JACKET	MATERIAL/COLOR	/	LSOH/95A Orange RAL 2003			
	OUTER DIA.	mm	7.7 ± 0.2mm			
	CONCENTRIC	%	≥80%			
	NOM. THICKNESS	mm	0.50 ± 0.1MM			

MARKING: CAT7A S/FTP 1200MHz 4x2x23AWG/1 LSZH ISO11801 & EN50173 & ANSI/TIA568C.2 XXXM (50M OR 90M) www.synergy21.de **CE**

NOTE:

1. Installation temperature 0-50°C
2. Operation temperature -20-75°C
3. RoHS 3.0 & REACH compliant
4. 3P Certified
5. CPR Class Eca Certified

SYNERGY21

CUSTOMER NAME	AN	NAME	CAT. 7A S/FTP Solid CABLE 23AWG		
ITEM NO.			PICTURE SHOWS	TOLERANCE	
manufacture country:	CHINA			X.	±1.00
APPROVED	AUDIT	DRAWING	UNITS	mm	
SYNERGY21	SYNERGY21	SYNERGY21	PAGE	1/1	

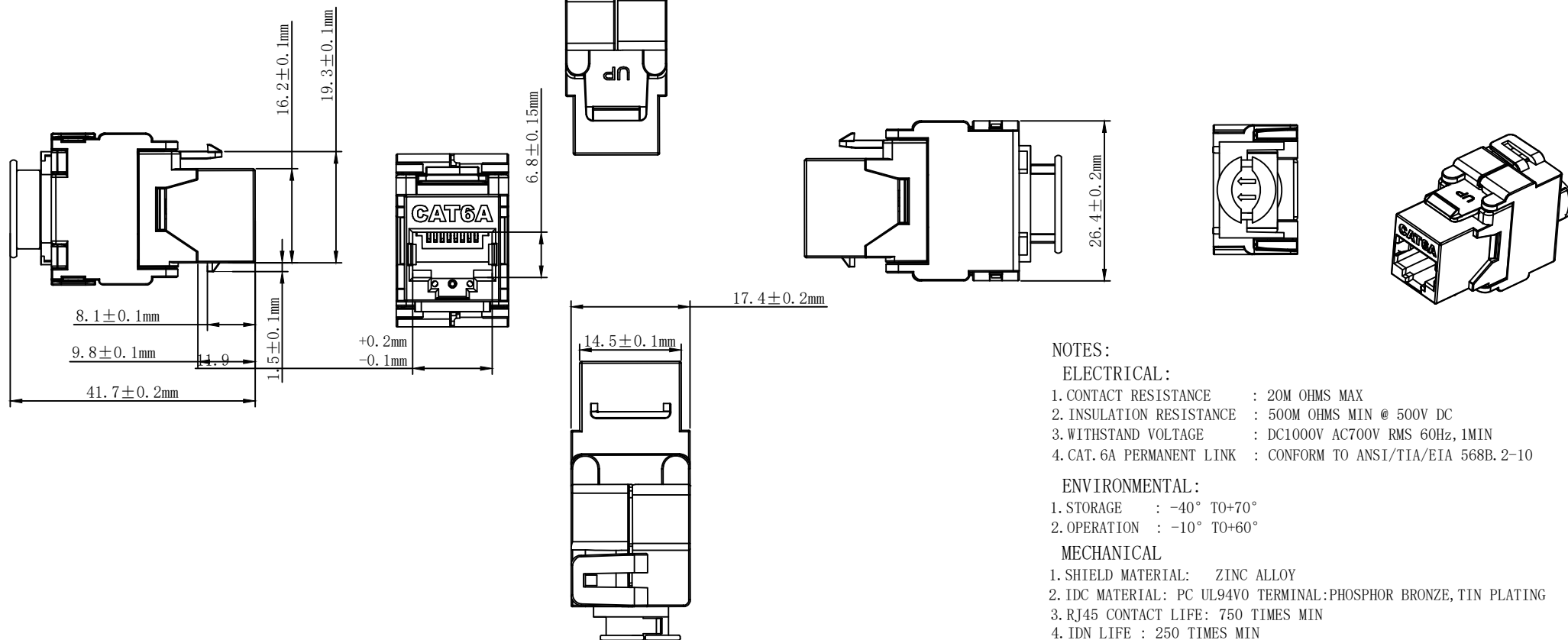

- NOTES:
- ELECTRICAL:**
- CONTACT RESISTANCE : 20M OHMS MAX
 - INSULATION RESISTANCE : 500M OHMS MIN @ 500V DC
 - WITHSTAND VOLTAGE : DC1000V AC700V RMS 60Hz, 1MIN
 - CAT. 6A PERMANENT LINK : CONFORM TO ANSI/TIA/EIA 568B. 2-10
- ENVIRONMENTAL:**
- STORAGE : -40° TO+70°
 - OPERATION : -10° TO+60°
- MECHANICAL**
- SHIELD MATERIAL: ZINC ALLOY
 - IDC MATERIAL: PC UL94V0 TERMINAL:PHOSPHOR BRONZE, TIN PLATING
 - RJ45 CONTACT LIFE: 750 TIMES MIN
 - IDN LIFE : 250 TIMES MIN
 - RJ45 DIMENSION:11.9MM*9.8MM
 - WEIGHT: 34.7G
- TYPE**
- SHIELDED CAT. 6A KEYSTONE JACK
 - COLOUR:SILVERY WHITE
- RoHS 3.0&REACH COMPLIANT

MATERIAL LIST:

⑦	MODULAR COVER	FIREPROOF PC UL94V0	1	
⑥	RJ 45 JACK INSERT	8P8C 3U" GOLD PLATED	8	
⑤	PCB	1.6mm UL 94V0	1	
④	IDC BODY	FIREPROOF/PC UL 94V0	1	
③	IDC PIN	PHOSPHOR BRONZE & TINNED	8	
②	LABEL COLOR CODE	T568A/B	2	
①	IDC TERMINAL	FOR 22-26AWG CABLE	1	
NO.	PARTS NAME	SPECIFICATION STANDARD	QT' Y	REMARK

SYNERGY21									
CUSTOMER	AN			ITEM NO.					
PRODUCT NAME	CAT. 6A STP KEYSTONE JACK	manufacture country:	CHINA	UNIT	MM				
	DRAWNBY	CHECKBY	APPOBY	DATE					
BY	CHK	SYNERGY21	SYNERGY21	SYNERGY21	2022-07-15				

NEW			2022-07-15	A
REVISION RECORD MODIFICATIONS			DATE	REV.

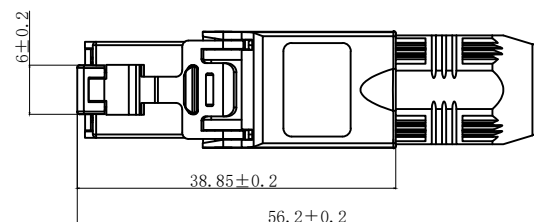
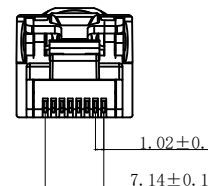
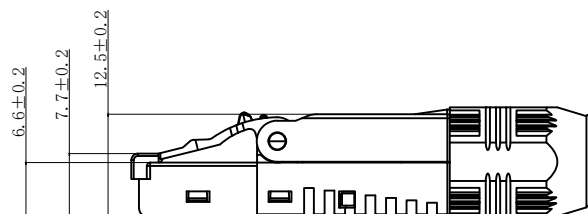
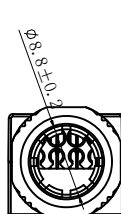
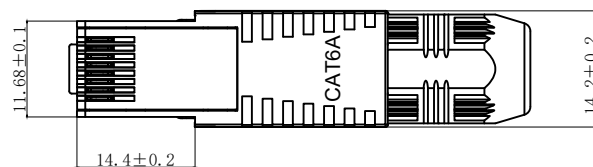
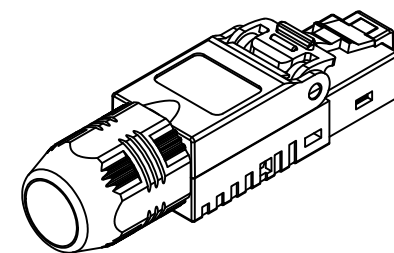

NOTES:

ELECTRICAL:

- 1. Contact Resistance : 20MΩ MAX
- 2. Insulation Resistance : 500MΩ MIN @ 500V DC
- 3. Withstand Voltage : DC 1000V AC 700V RMS 60Hz, 1MIN
- 4. Component testing for ANSI-TIA568.2-D MPTL requirements IEC 60603-7-5
CAT.6A /Class EA MPTL Test pass

ENVIRONMENTAL:

- 1. Storage temperature : -40° TO+70°
- 2. Operation temperature : -10° to+60°

MECHANICAL

- 1. Housing MATERIAL: Zinc alloy
- 2. IDC MATERIAL: PC TERMINAL:PHOSPHOR BRONZE, TIN PLATING
- 3. RJ45 Contact Life: 750 Times Min
- 4. Plug inforce:<30N
- 5. Solid cable:1/22AWG(0.65MM)-1/26AWG(0.4MM) ID:1.1MM-1.6MM
- 6. Stranded cable:7/22AWG(7/0.254mm)-7/27AWG(7/0.14mm) ID:1.1MM-1.6MM
- 7. Cable OD: 5.0mm-8.5mm
- 8. PoE per IEEE 802.3af, PoE+ per IEEE 802.3at, PoE++ per IEEE 802.3bt,
RoHS 3.0 and REACH Compliant

⑦	Sheel	Zinc alloy	2	
⑥	Housing	Zinc alloy	1	
⑤	MODULAR COVER	PC label color code T568A/B	1	
④	RJ 45 Plug	8P8C GOLD PLATED	8	
③	PCB	1.0mm UL 94V0	1	
②	IDC PIN	PHOSPHOR BRONZE & TINNED	8	
①	IDC TERMINAL	FOR 22-27AWG CABLE	8	
NO.	PARTS NAME	SPECIFICATION STANDARD	QT' Y	REMARK

SYNERGY21									
CUSTOMER		AN		ITEM NO.					
PRODUCT NAME		Field Installable RJ 45 shielded with screw type upwards openable L:56.3mm		manufacture country:		CHINA	UNIT	MM	
NEW		2022-07-15		A	DRAWNBY	CHECKBY	APPOBY	DATE	
BY	CHK	REVISION RECORD MODIFICATIONS		DATE	REV.	SYNERGY21	SYNERGY21	SYNERGY21	2022-07-15

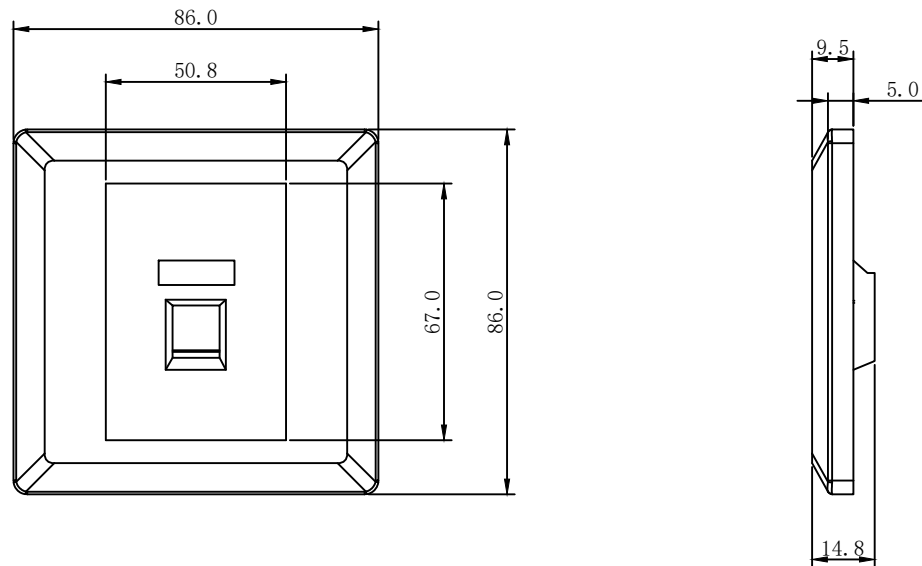

Materials:

Outlet Housing: Fireproof ABS UL-94V0/Colour:RAL 9010

Outlet Base:Fireproof ABS UL-94V0/Colour:RAL 9010

ACCESSORY :

1. Screw:M3*25mm*2pcs

RoHS 3.0 & REACH Compliant

SYNERGY21										
CUSTOMER		AN			ITEM NO.					
PRODUCT NAME	FACE PLATE 1 PORT	manufacture country:		CHINA	UNIT	MM				
		NEW			2022-07-15	A	DRAWNBY	CHECKBY	APPOBY	DATE
BY	CHK	REVISION RECORD MODIFICATIONS			DATE	REV.	SYNERGY21	SYNERGY21	SYNERGY21	2022-07-15