



LPS8 LoRaWAN Gateway User Manual

Document Version: 1.3.0

Firmware Version: lgw--build-v5.4.1615882321-20210316-1613

Version	Description	Date
1.0	Release	2019-Aug-10
1.0.1	Add trouble shooting for wifi AP not access issue	2019-Sep-23
1.0.2	Change the HTTP Port and SSH port for firmware version > v5.3	2019-Oct-26
1.1.0	Add more features such packet filter, remote access	2020-Mar-02
1.1.1	Polish network access description to make it clear	2020-Mar-16
1.2.0	Add TTN server explain, change to use new UI and firmware	2020-May-27
1.3.0	Add Auto – provision (system --> Remote Mgmt)	2021-Jan-3
1.3.1	Add Amazon AWS-IoT Support	2021-Mar-27
1.3.2	Change to use TTNv3	2021-Jul-5

Table of Contents

1	Introduction	5
1.1	What is the LPS8	5
1.2	Specifications	6
1.3	Features	7
1.4	Hardware System Structure	7
1.5	LPS8 Applications	8
1.6	LED Indicators	8
2	Access and Configure LPS8	9
2.1	Find IP address of LPS8	9
2.1.1	Connect via WiFi	9
2.1.2	Connect via Ethernet with DHCP IP from router	9
2.1.3	Connect via WiFi with DHCP IP from router	10
2.1.4	Connect via Ethernet with fall back ip	10
2.2	Access Configure Web UI	11
3	Typical Network Setup	12
3.1	Overview	12
3.2	Use WAN port to access Internet	12
3.3	Access the Internet as a WiFi Client	13
3.4	Check Internet connection	13
4	Example: Configure as a LoRaWAN gateway	14
4.1	Create a gateway in TTN V3 Server	15
4.2	Configure LPS8 to connect to TTN v3	18
4.3	Configure frequency	20
4.4	Add a LoRaWAN End Device	21
5	Web Configure Pages	24
5.1	Home	24

5.2	<i>LoRa Settings</i>	25
5.2.1	LoRa --> LoRa	25
5.2.2	LoRa --> ABP Decryption	26
5.3	<i>LoRaWAN Settings</i>	27
5.3.1	LoRaWAN --> LoRaWAN	27
1.1.1	LoRaWAN --> Amazon AWS-IoT	27
5.3.2	LoRaWAN --> LORIoT	27
5.4	<i>MQTT Settings</i>	29
5.5	<i>System</i>	30
5.5.1	System --> System Overview.....	30
5.5.2	System --> General (login settings)	30
5.5.3	System --> Network	32
5.5.4	System --> WiFi	33
5.5.5	System --> Network Status.....	33
5.5.6	System --> Remote Mgnt & Auto Update	34
5.5.7	System --> Firmware Upgrade	36
5.5.8	System --> Reboot/Reset	37
5.5.9	System --> Package Maintain	38
6	More features	39
6.1	<i>Packet Filtering</i>	39
6.2	<i>Remote Access</i>	39
6.3	<i>How to decode ABP LoRaWAN node</i>	39
6.4	<i>How to set data to MQTT broker</i>	39
6.5	<i>More instructions</i>	39
6.6	<i>Auto-Provision</i>	40
7	Linux System	41
7.1	<i>SSH Access for Linux console</i>	41
7.2	<i>Edit and Transfer files</i>	42
7.3	<i>File System</i>	42
7.4	<i>Package maintenance system</i>	43
8	Upgrade Linux Firmware	44
8.1	<i>Upgrade via Web UI</i>	44
8.2	<i>Upgrade via Linux console</i>	45
9	FAQ	46

9.1	<i>How can I configure for a customized frequency band?.....</i>	46
9.2	<i>Can I make my own firmware for the gateway, Where can I find the source code?</i>	46
9.3	<i>Can I use 868Mhz version for 915Mhz bands?.....</i>	46
10	Trouble Shooting.....	47
10.1	<i>I get kernel error when install new package, how to fix?</i>	47
10.2	<i>How to recover the LPS8 if the firmware crashes</i>	47
10.3	<i>I configured LPS8 for WiFi access and lost its IP. What to do now?</i>	48
10.4	<i>I connect to the LPS8's SSID but LPS8 didn't assign DHCP IP to my laptop?</i>	49
11	Order Info	49
12	Packing Info	50
13	Support.....	50
14	FCC Warning	50

1 Introduction

1.1 What is the LPS8

The LPS8 is an **open source** LoRaWAN Gateway. It lets you bridge LoRa wireless network to an IP network via **WiFi, Ethernet**. The LoRa wireless allows users to send data and reach extremely long ranges at low data-rates.

The LPS8 uses **Semtech packet forwarder** and fully compatible with LoRaWAN protocol. It includes a **SX1308 LoRa concentrator**, which provides 10 programmable parallel demodulation paths.

LPS8 has **pre-configured standard LoRaWAN frequency bands** to use for different countries. User can also **customize the frequency bands** to use in their own LoRa network.

LPS8 In a LoRaWAN IoT Network:

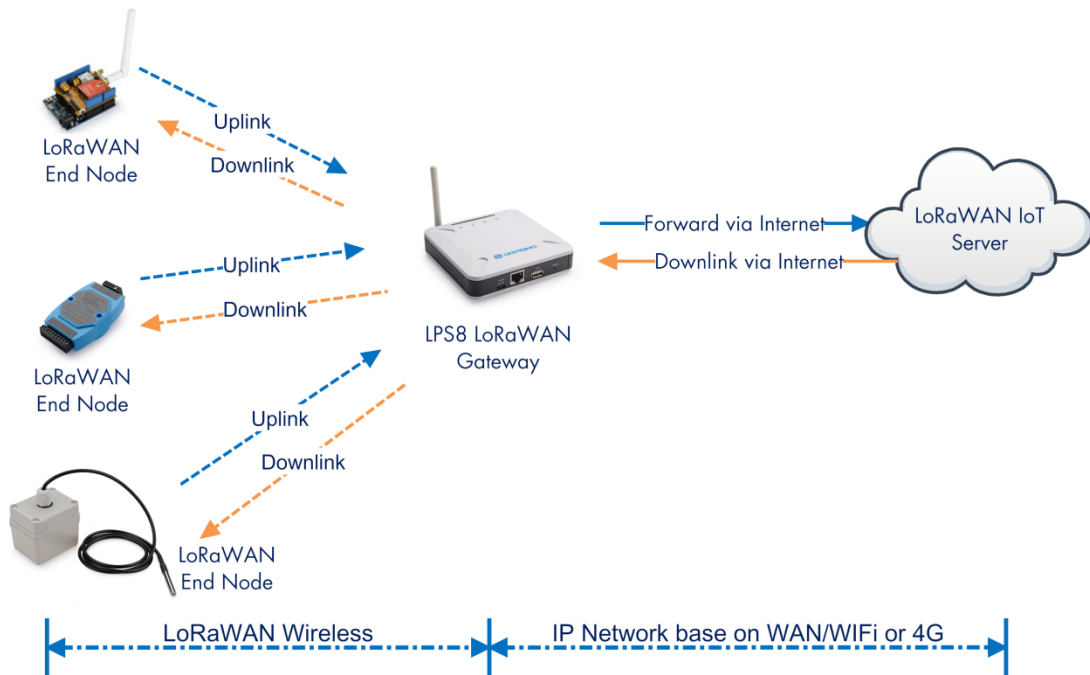

1.2 Specifications

Hardware System:

Linux Part:

- 400Mhz ar9331 processor
- 64MB RAM
- 16MB Flash

Interface:

- 10M/100M RJ45 Ports x 1
- WiFi : 802.11 b/g/n
- LoRaWAN Wireless
- Power Input: 5V DC, 2A, Type C
- USB 2.0 host connector x 1

WiFi Spec:

- IEEE 802.11 b/g/n
- Frequency Band: 2.4 ~ 2.462GHz
- Tx power:
 - ✓ 11n tx power : mcs7/15: 11db mcs0 : 17db
 - ✓ 11b tx power: 18db
 - ✓ 11g 54M tx power: 12db
 - ✓ 11g 6M tx power: 18db
- Wifi Sensitivity
 - ✓ 11g 54M : -71dbm
 - ✓ 11n 20M : -67dbm

LoRa Spec:

- Up to -140 dBm sensitivity with SX1257 Tx/Rx front-end
- 70 dB CW interferer rejection at 1 MHz offset
- Able to operate with negative SNR, CCR up to 9dB
- Emulates 49 x LoRa demodulators and 1 x (G)FSK demodulator
- Dual digital TX & RX radio front-end interfaces
- 10 programmable parallel demodulation paths
- Dynamic data-rate (DDR) adaptation
- True antenna diversity or simultaneous dual-band operation

Max Power: 5v, 1.3A

1.3 Features

- ✓ Open Source OpenWrt system
- ✓ Managed by Web GUI, SSH via WAN or WiFi
- ✓ Remote access with Reverse-SSH
- ✓ Emulates 49x LoRa demodulators
- ✓ LoRaWAN Gateway
- ✓ 10 programmable parallel demodulation paths
- ✓ Pre-configure to support different LoRaWAN regional settings.
- ✓ Allow to customize LoRaWAN regional parameters.
- ✓ Support Local decode ABP end node info and transfer to MQTT server
- ✓ Support different level log in.

1.4 Hardware System Structure

LPS8 System Overview:

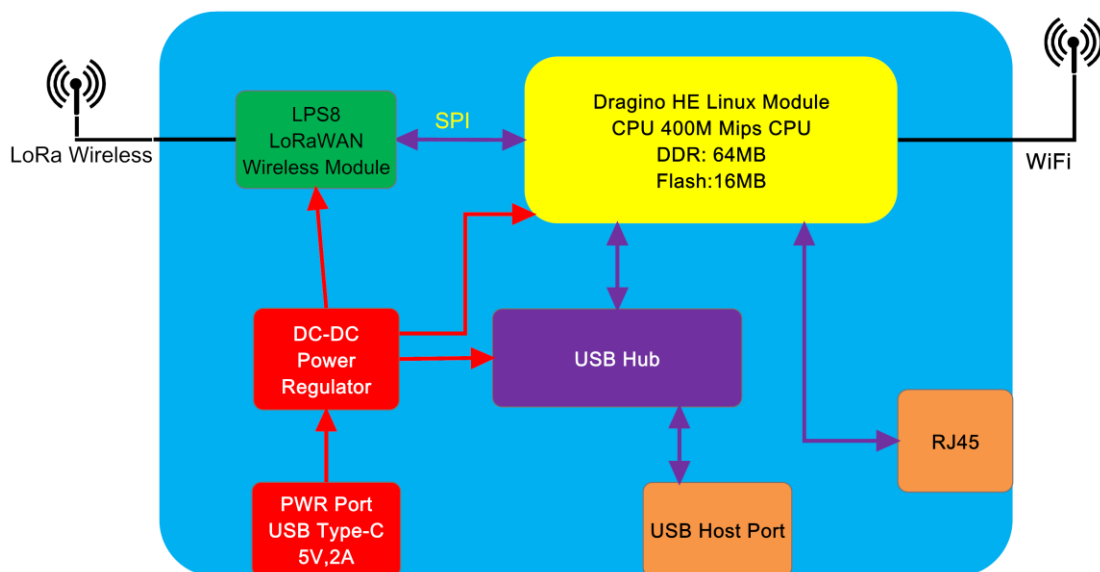





1.5 LPS8 Applications



1.6 LED Indicators

LPS8 has totally four LEDs, They are:

- **Power LED** : This **RED LED** will be **solid on** if the device is properly powered.
- **LoRa LED** : This **RGB LED** will **blink GREEN** when LoRaWAN module starts or transmit a packet.
- **SYS LED** : This **RGB LED** will shows different colors on different state:
 - ✓ **SOLID BLUE**: Device is alive with LoRaWAN server connection.
 - ✓ **BLINKING BLUE**: a) Device has internet connection but no LoRaWAN Connection. or b) Device is in booting stage, in this stage, it will **BLINKING BLUE** for several seconds and then with **SOLID RED and BLINKING BLUE** together
 - ✓ **SOLID RED**: Device doesn't have Internet connection.
- **ETH LED** : This LED shows the ETH interface connection status.

2 Access and Configure LPS8

The LPS8 is configured as a WiFi Access Point by factory default. You can access and configure the LPS8 after connecting to its WiFi network, or via its WAN Ethernet port.

2.1 Find IP address of LPS8

2.1.1 Connect via WiFi



At the first boot of LPS8, it will auto generate a WiFi network called **dragino-xxxxxx** with password:

dragino+dragino

You can use a PC to connect to this WiFi network. The PC will get an IP address 10.130.1.xxx and the LPS8 has the default IP **10.130.1.1**



2.1.2 Connect via Ethernet with DHCP IP from router

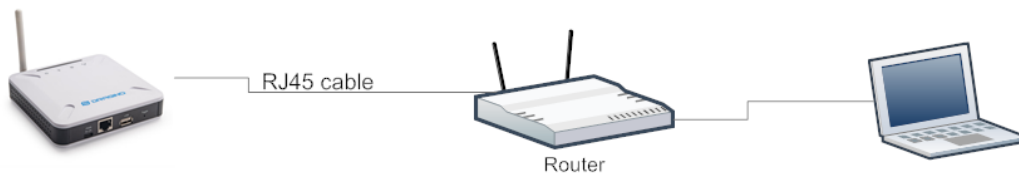

Alternatively, connect the LPS8 Ethernet port to your router and LPS8 can obtain an IP address from your router. In the router's management portal, you should be able to find what IP address the router has assigned to the LPS8. You can also use this IP to connect.

2.1.3 Connect via WiFi with DHCP IP from router



If the LPS8 already connect to the router via WiFi, use can use the WiFi IP to connect to LPS8.

2.1.4 Connect via Ethernet with fall back ip

The WAN port also has a [fall back ip address](#) for access if user doesn't connect to uplink router. Click [here to see how to configure](#).

2.2 Access Configure Web UI

Web Interface

Open a browser on the PC and type in the LPS8 ip address (depends on your connect method)

<http://10.130.1.1/> (Access via WiFi AP network)

or

http://IP_ADDRESS or http://IP_ADDRESS:8000 (The web port has been changed to 8000 in **WAN interface**(WAN port or WiFi Client Mode) since firmware 5.3.xxx firmware)

You will see the login interface of LPS8 as shown below.

The account details for Web Login are:

User Name: root

Password: dragino

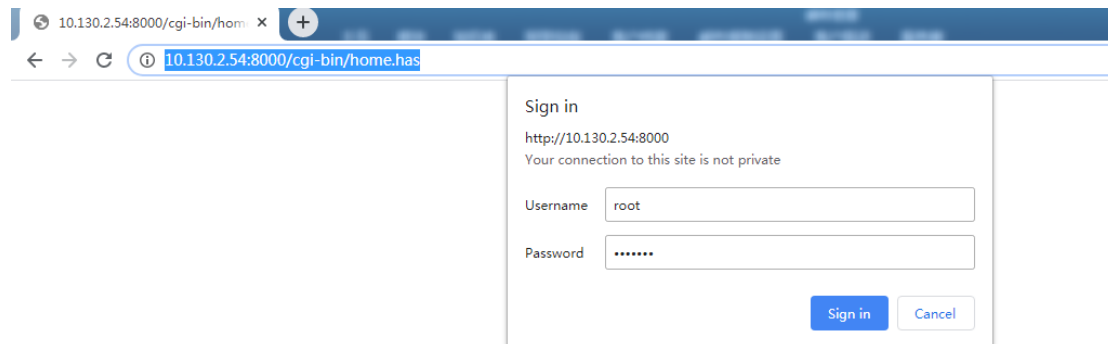

3 Typical Network Setup

3.1 Overview

The LPS8 supports flexible network set up for different environments. This section describes the typical network topology can be set in LPS8. The network set up includes:

- ✓ **WAN Port Internet Mode**
- ✓ **WiFi Client Mode**
- ✓ **WiFi AP Mode**

3.2 Use WAN port to access Internet

By default, the LPS8 is set to use the WAN port to connect to an upstream network. When you connect the LPS8's WAN port to an upstream router, LPS8 will get an IP address from the router and have Internet access via the upstream router. The network status can be checked as below:

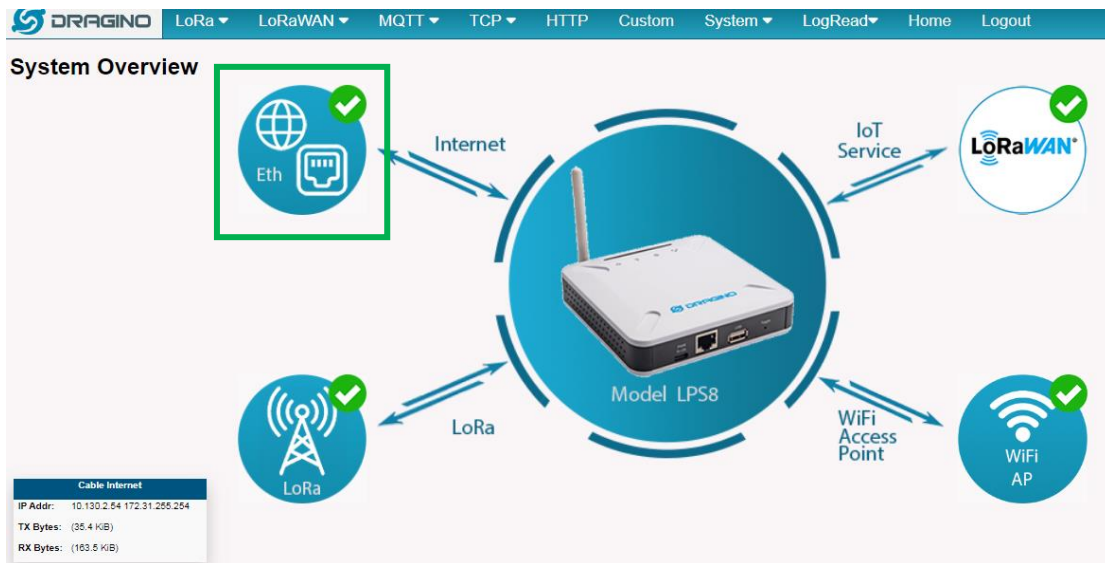

3.3 Access the Internet as a WiFi Client.

In the WiFi Client Mode, LPS8 acts as a WiFi client and gets DHCP from an upstream router via WiFi.

The settings for WiFi Client is under page [System](#) → [WiFi](#) → [WiFi WAN Client Settings](#)

WiFi

Radio Settings

Channel (1-11) Tx Power (0-18) dBm

WiFi Access Point Settings

Enable WiFi Access Point

WiFi Name SSID

Passphrase (8-32 char) [Show](#) Encryption

WiFi WAN Client Settings

Enable WiFi WAN Client

Host WiFi SSID WiFi Survey

Passphrase [Show](#) Encryption

[Save&Apply](#) [Cancel](#) [Refresh](#)

In the WiFi Survey Choose the WiFi AP, and input the Passphrase then click Save & Apply to connect.

3.4 Check Internet connection

In the [Home](#) page, we can check the Internet connection.

- GREEN Tick : This interface has Internet connection.
- Yellow Tick : This interface has IP address but don't use it for internet connection.
- RED Cross : This interface doesn't connected.

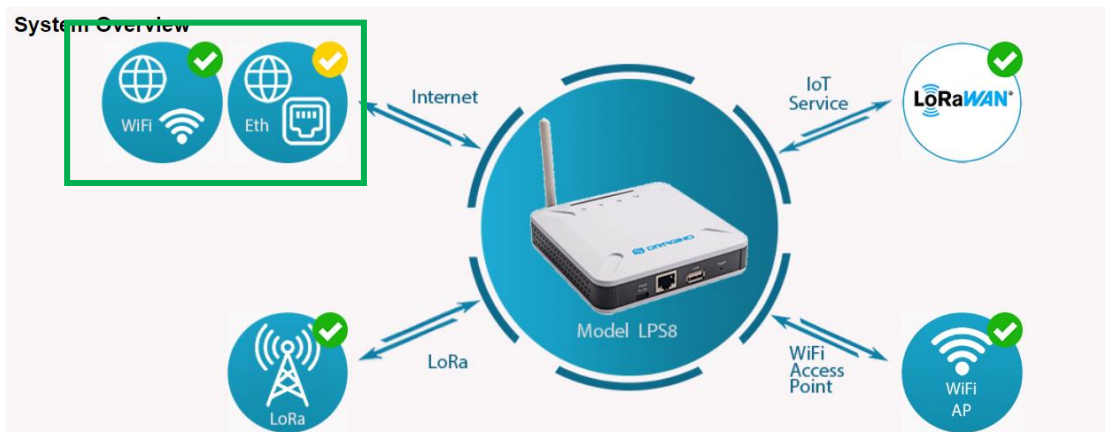

4 Example: Configure as a LoRaWAN gateway

LPS8 is fully compatible with LoRaWAN protocol. It uses the legacy Semtech Packet forwarder to forward the LoRaWAN packets to server. The structure is as below.

LPS8 In a LoRaWAN IoT Network:

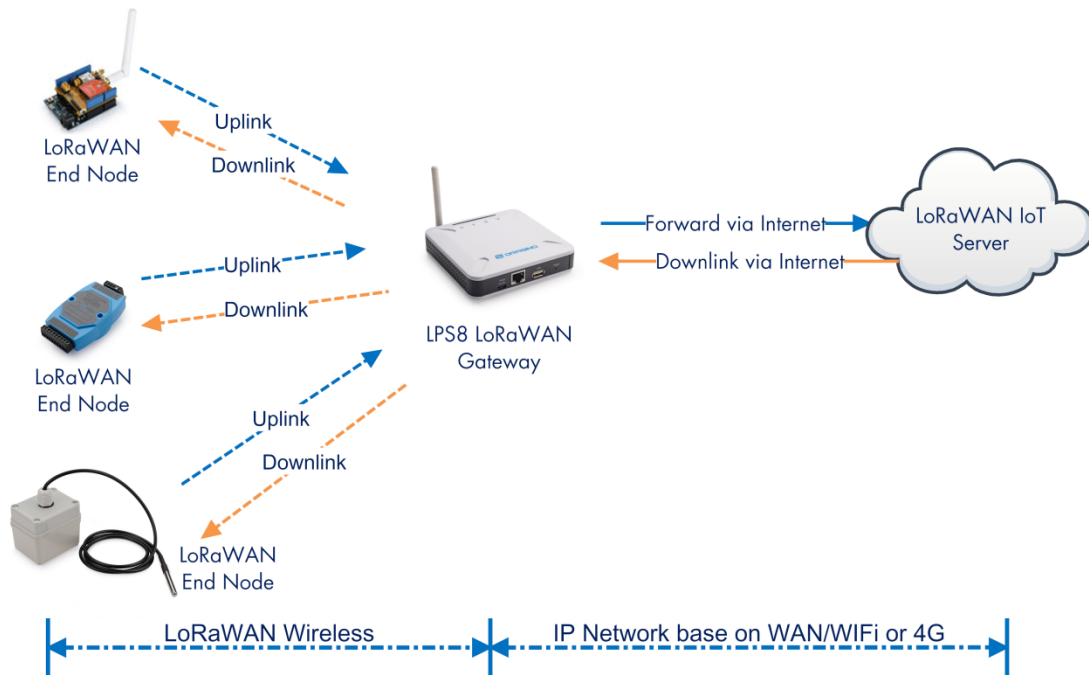

This chapter describes how to use the LPS8 to work with

[TheThingsNetwork v3\(TTN v3\) LoRaWAN Server](http://www.thethingsnetwork.org) (www.thethingsnetwork.org)

4.1 Create a gateway in TTN V3 Server

Step 1: Get a Unique gateway ID.

Every LPS8 has a unique gateway id. The ID can be found at LoRaWAN page:

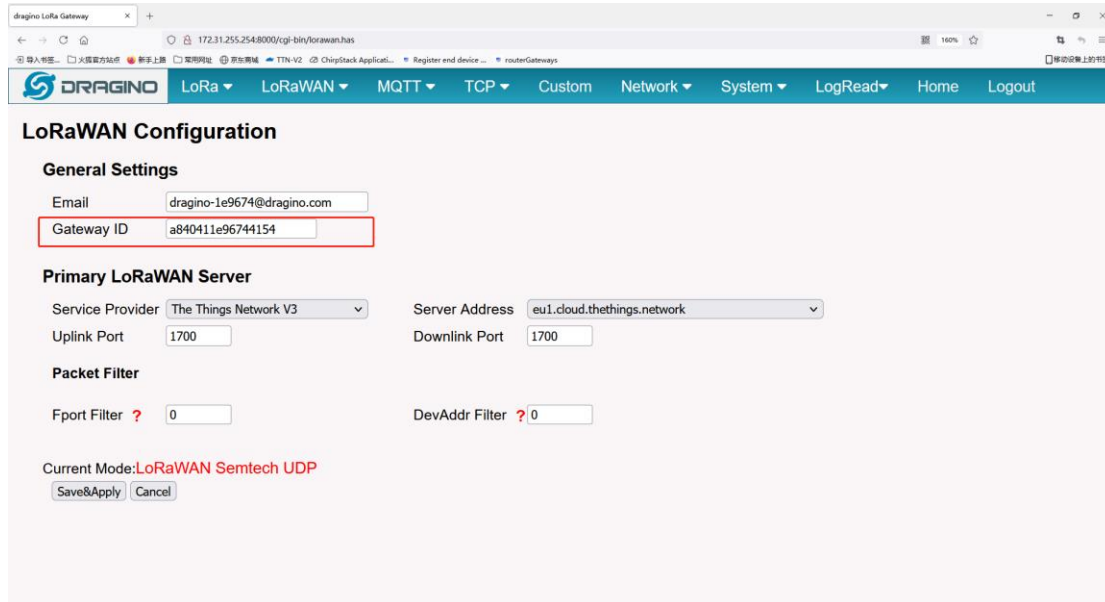

The screenshot shows the 'LoRaWAN Configuration' page in a web browser. The 'General Settings' section includes an 'Email' field with 'dragino-1e9674@dragino.com' and a 'Gateway ID' field with 'a840411e96744154'. The 'Primary LoRaWAN Server' section shows 'The Things Network V3' as the service provider and 'eu1.cloud.thethings.network' as the server address. The 'Packet Filter' section has 'Fport Filter' and 'DevAddr Filter' both set to '0'. The current mode is 'LoRaWAN Semtech UDP'.

The example gateway id is: **a840411e96744154**

Step 2: Sign up a user account in TTN server

<https://account.thethingsnetwork.org/register>

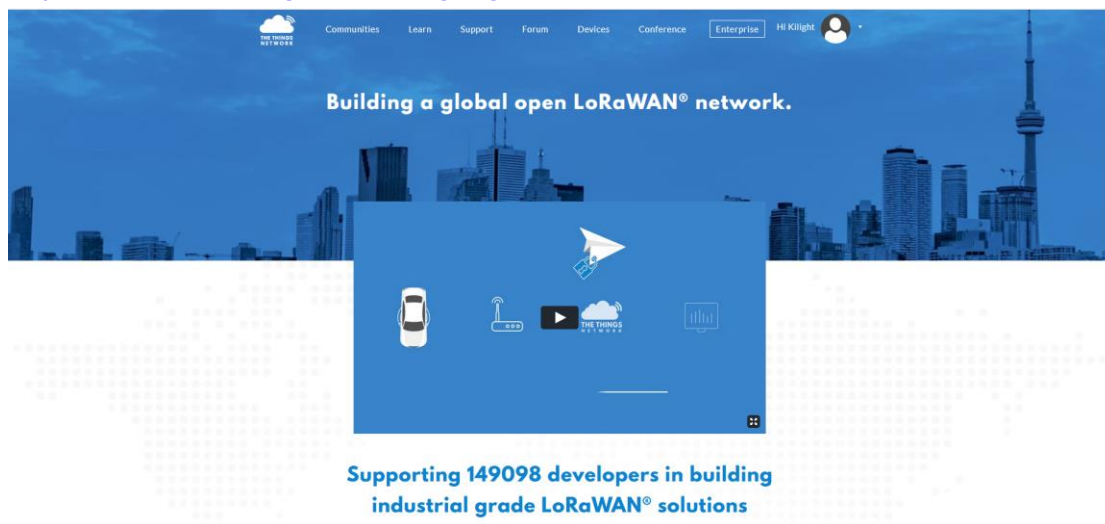

Step 3: Choose the TTNv3 Cluster Picker

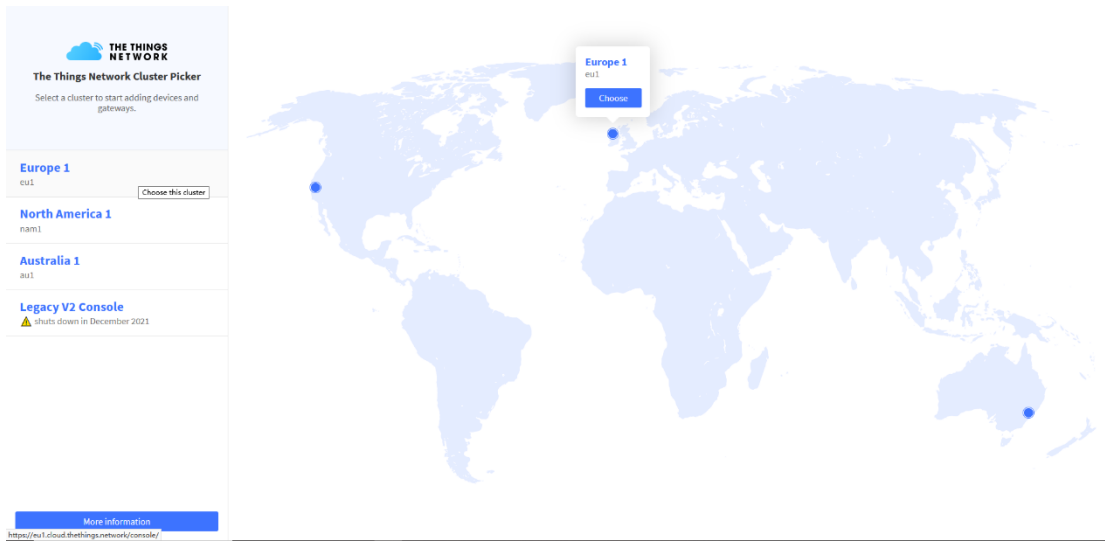

Note: Choose the cluster corresponds to a specific Gateway server address

- Europe 1 **corresponding Gateway server address:** eu1.cloud.thethings.network
- North America 1 **corresponding Gateway server address:** nam1.cloud.thethings.network
- Australia 1 **corresponding Gateway server address:** au1.cloud.thethings.network
- Legacy V2 Console : **TTN v2 shuts down in December 2021**

Step 4: Create a Gateway

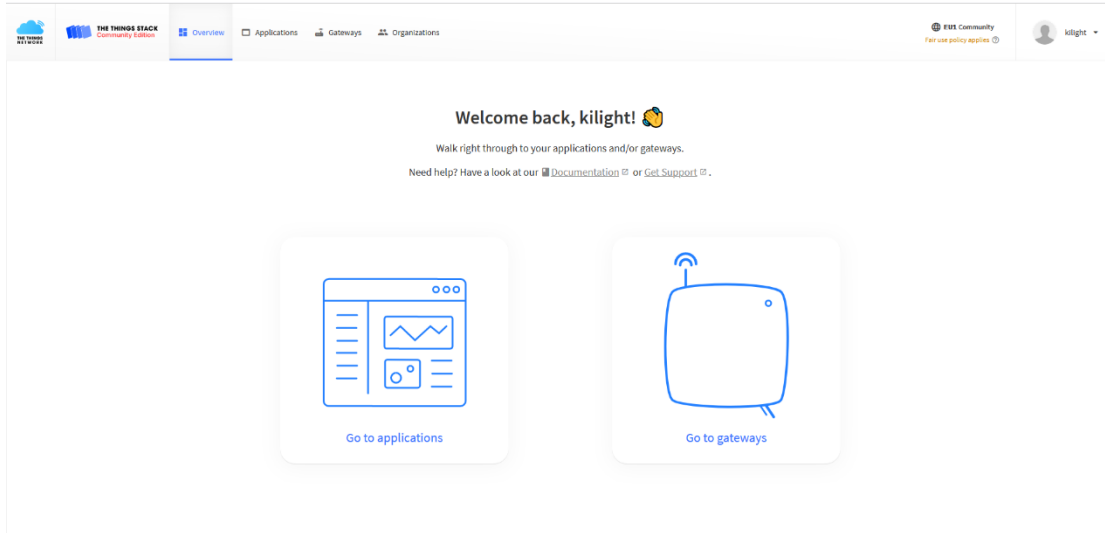

Click the Gateway icon and then click Add gateway.

Open the following page:

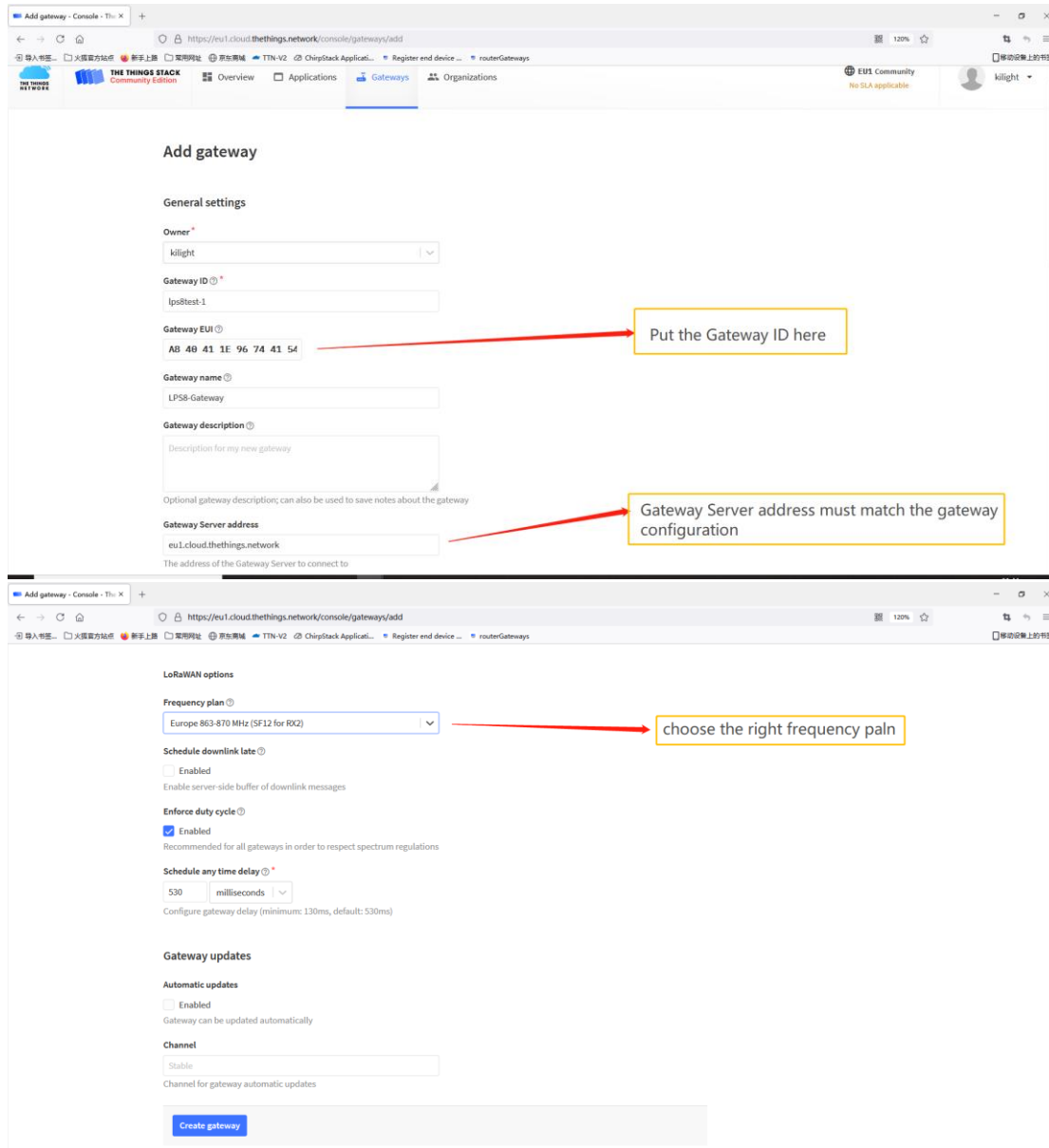

Notice: Gateway Server address must match the gateway configuration, otherwise you will have problem for End Node to join the network.

After creating the gateway, you can see the gateway info, as below.

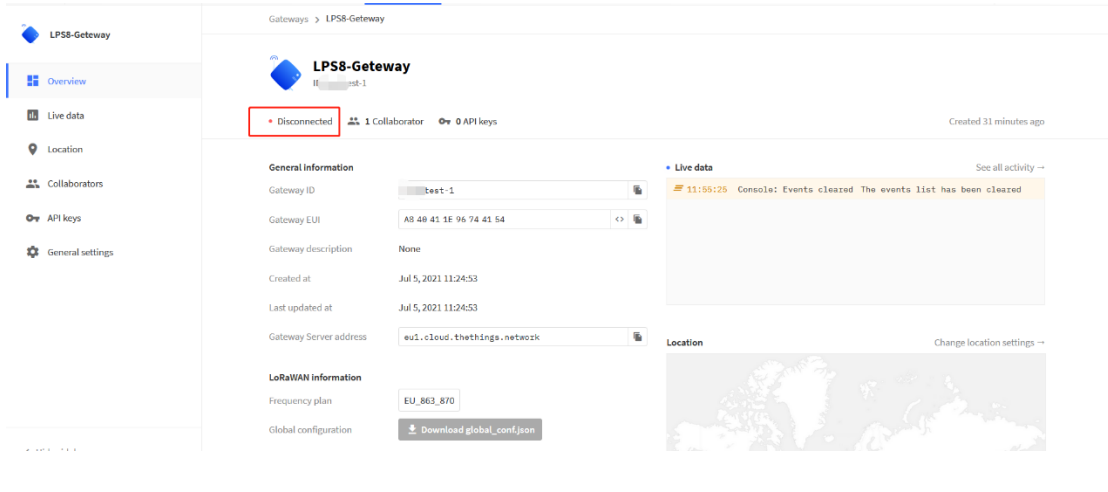

4.2 Configure LPS8 to connect to TTN v3

You can now configure the LPS8 to let it connect to TTN network V3.
Make sure your LPS8 has a working Internet Connection first.

Choose the right server provider and click [Save&Apply](#)

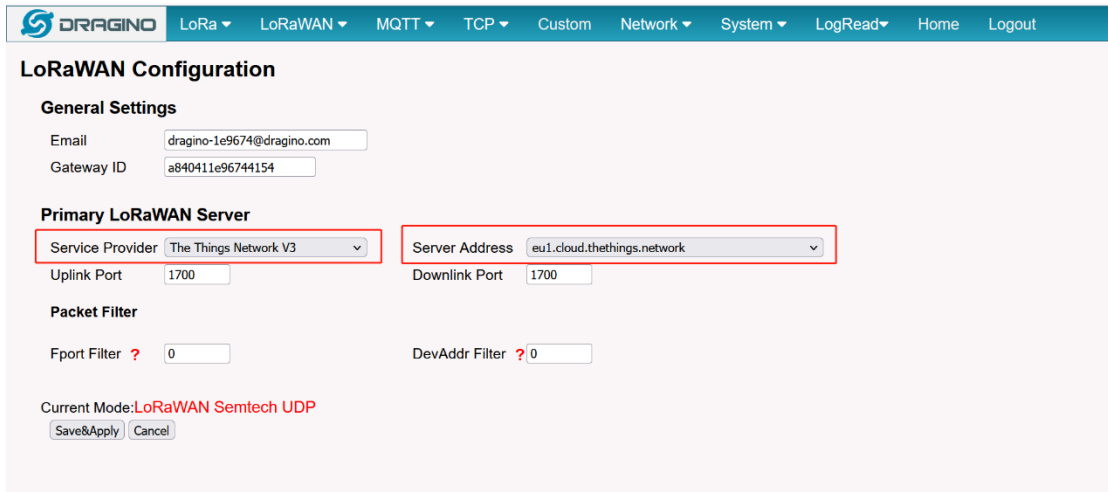

Note: The server address must match the Gateway server address you choose in TTN V3.

In the home page, we can see the LoRaWAN connection is ready now.

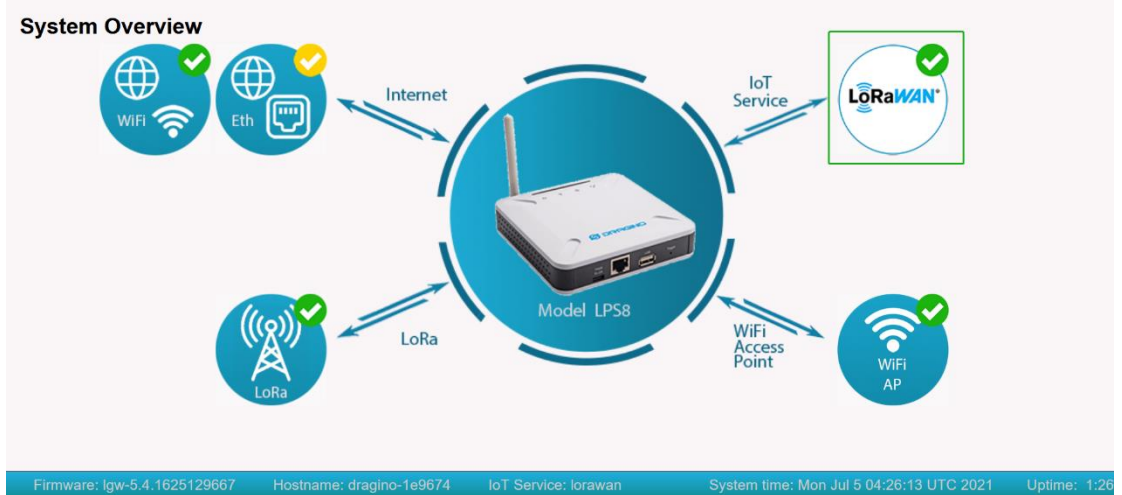

In TTN v3 portal, we can also see the gateway is connected.

The screenshot shows the TTN v3 portal interface for the LPS8-Gateway. The page is titled "LPS8-Gateway" and includes the following information:

- Gateway ID:** ID: [redacted]-1
- Gateway EUI:** A8 40 41 1E 96 74 41 54
- Gateway description:** None
- Created at:** Jul 5, 2021 11:24:53
- Last updated at:** Jul 5, 2021 11:24:53
- Gateway Server address:** eu1.cloud.thethings.network
- LoRaWAN information:** Frequency plan: EU_863_870

The "Live data" section shows the following activity:

- 12:28:18 Receive gateway status Metrics: { ackr: 0, rxfw: 4, rxin: 4, }
- 12:28:00 Receive uplink message DevAddr: 48 00 00 00 FCnt: 1100 F
- 12:27:51 Receive uplink message DevAddr: 48 00 00 00 FCnt: 1096 F
- 12:27:47 Receive uplink message DevAddr: 48 00 00 00 FCnt: 1095 F
- 12:27:42 Receive uplink message DevAddr: 48 00 00 00 FCnt: 1094 F
- 12:27:40 Receive gateway status Metrics: { ackr: 0, rxfw: 4, rxin: 6, }

4.3 Configure frequency

We also need to set the frequency plan in LPS8 to match the end node we use, so to receive the LoRaWAN packets from the LoRaWAN sensor.

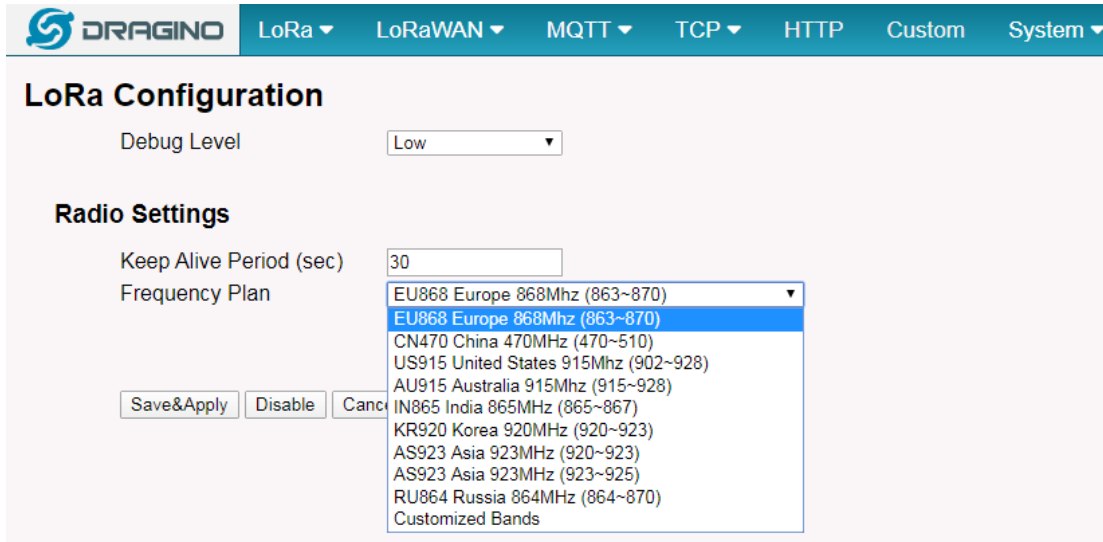

LoRa Configuration

Debug Level:

Radio Settings

Keep Alive Period (sec):

Frequency Plan:

- EU868 Europe 868Mhz (863~870)
- EU868 Europe 868Mhz (863~870)
- CN470 China 470MHz (470~510)
- US915 United States 915Mhz (902~928)
- AU915 Australia 915Mhz (915~928)
- IN865 India 865MHz (865~867)
- KR920 Korea 920MHz (920~923)
- AS923 Asia 923MHz (920~923)
- AS923 Asia 923MHz (923~925)
- RU864 Russia 864MHz (864~870)
- Customized Bands

In logread page, user can check the frequency actually used.

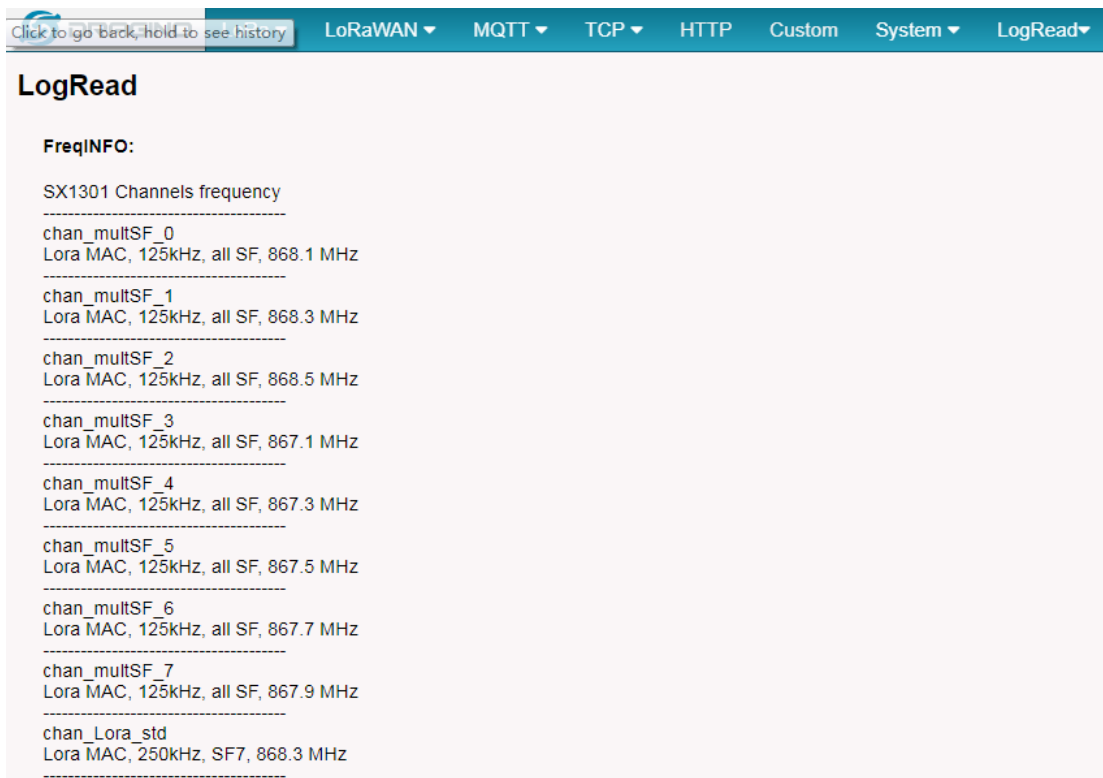

LogRead

FreqINFO:

SX1301 Channels frequency

chan_multSF_0
Lora MAC, 125kHz, all SF, 868.1 MHz

chan_multSF_1
Lora MAC, 125kHz, all SF, 868.3 MHz

chan_multSF_2
Lora MAC, 125kHz, all SF, 868.5 MHz

chan_multSF_3
Lora MAC, 125kHz, all SF, 867.1 MHz

chan_multSF_4
Lora MAC, 125kHz, all SF, 867.3 MHz

chan_multSF_5
Lora MAC, 125kHz, all SF, 867.5 MHz

chan_multSF_6
Lora MAC, 125kHz, all SF, 867.7 MHz

chan_multSF_7
Lora MAC, 125kHz, all SF, 867.9 MHz

chan_Lora_std
Lora MAC, 250kHz, SF7, 868.3 MHz

4.4 Add a LoRaWAN End Device

This section shows how to add a LoRaWAN End device to a LoRaWAN network and see the data from TTN web site.

We use [LT-22222-L](#) IO Controller as a reference device - the setup for other LoRaWAN devices will be similar.



Step 1: Create a Device definition in TTN v3 with the OTAA keys from the example LT-22222-L IO Controller device.

Three codes are required to define the device in TTN v3:

- ✓ DEV EUI - Unique ID code for a particular device.
- ✓ APP EUI - ID code for an Application defined in TTN v3.
- ✓ APP Key - Unique key to secure communications with a particular device.

A set of these codes are stored in each device by the manufacturer as the default codes for that particular device. Each device is shipped with a sticker with the default Device EUI as shown below.



Note: You may be able to change these codes in a device by using a configuration facility on the device e.g. the LT-22222 uses a serial port access and a series of AT commands. Changing the codes may be necessary in the case where you have to use codes assigned by a LoRa WAN server.

For the TTN v3 server, you can use the codes set in the device as in the following example.

Select **Add Application** to open the screen below.

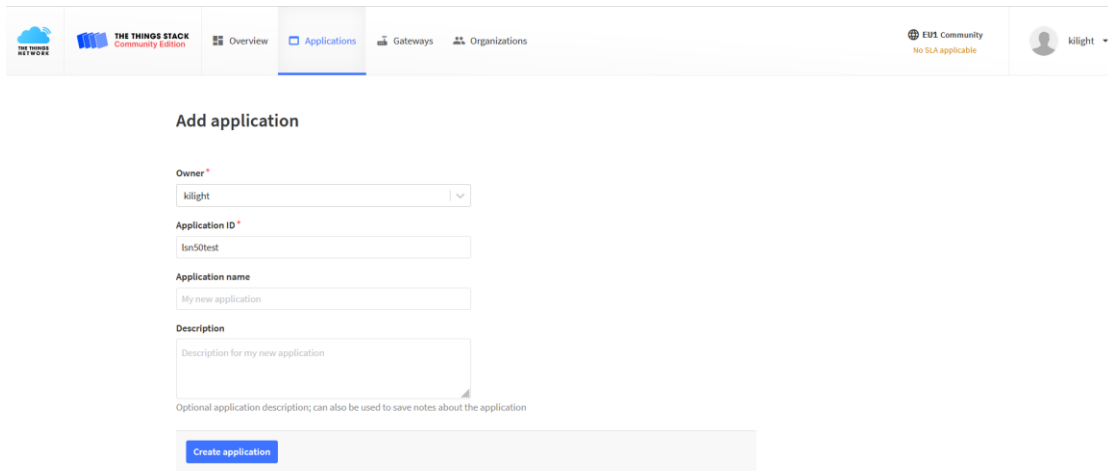

Open the **Application** select **Add end device**

Start Register the end device

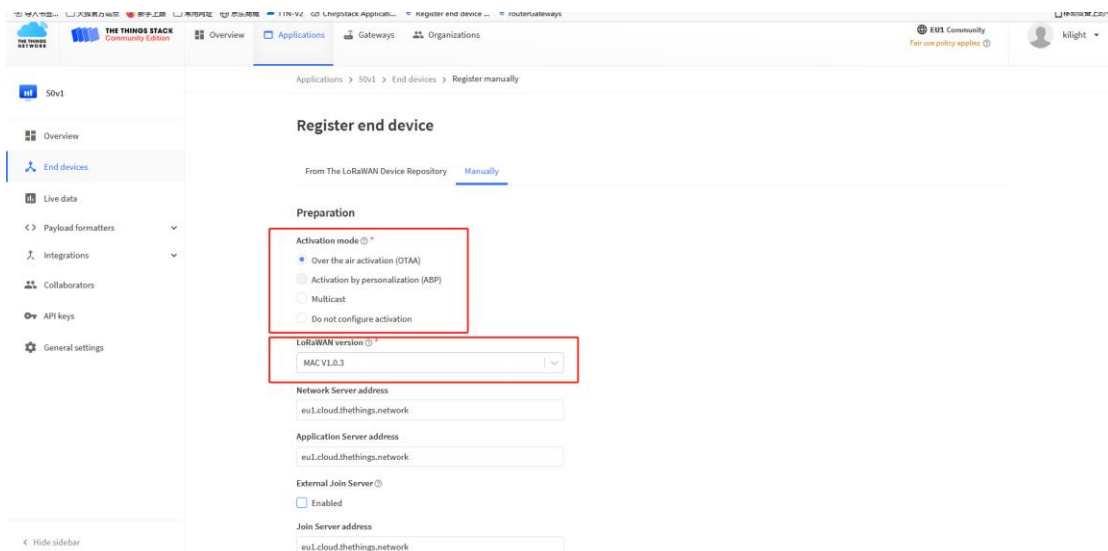

Select OTAA activation mode

The LoRaWAN version for your device should be provided by the manufacturer in a datasheet as LoRaWAN version or LoRaWAN specification. The most commonly used LoRaWAN versions are v1.0.2 and v1.0.3.

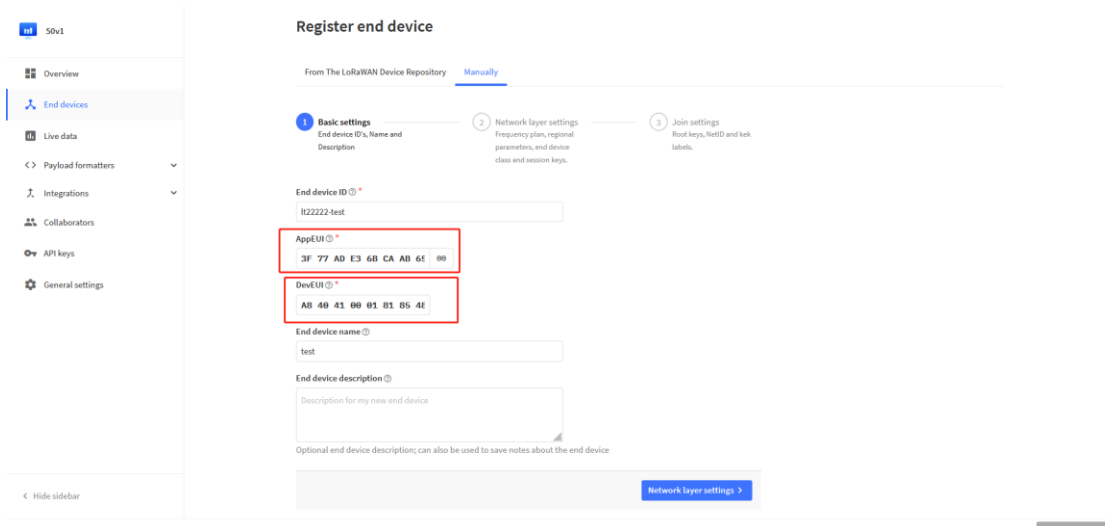

First, input the End device ID, AppEUI and DevEUI.

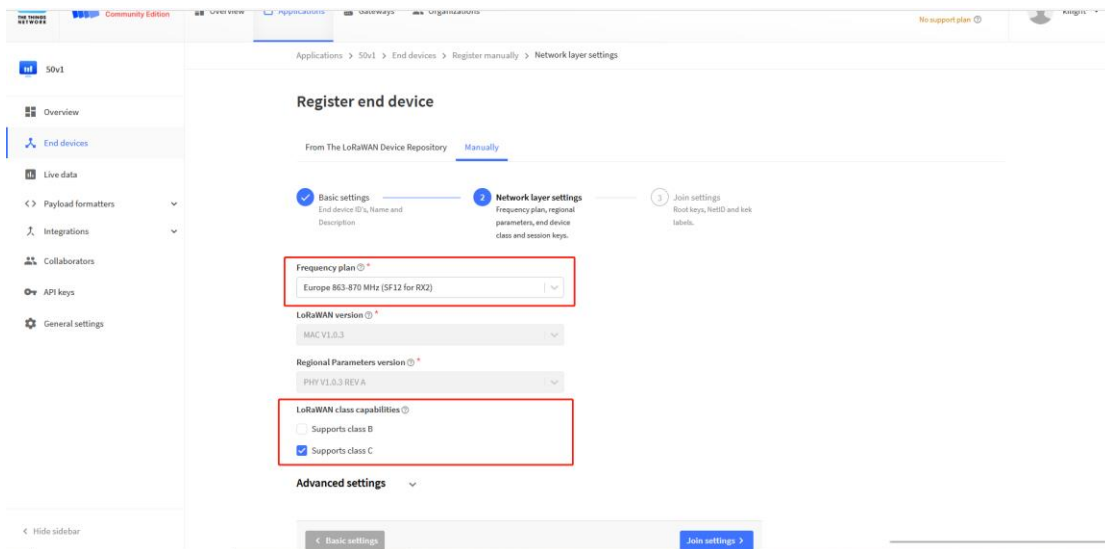

Secondly, choose the corresponding frequency and LoRaWAN class capabilities.

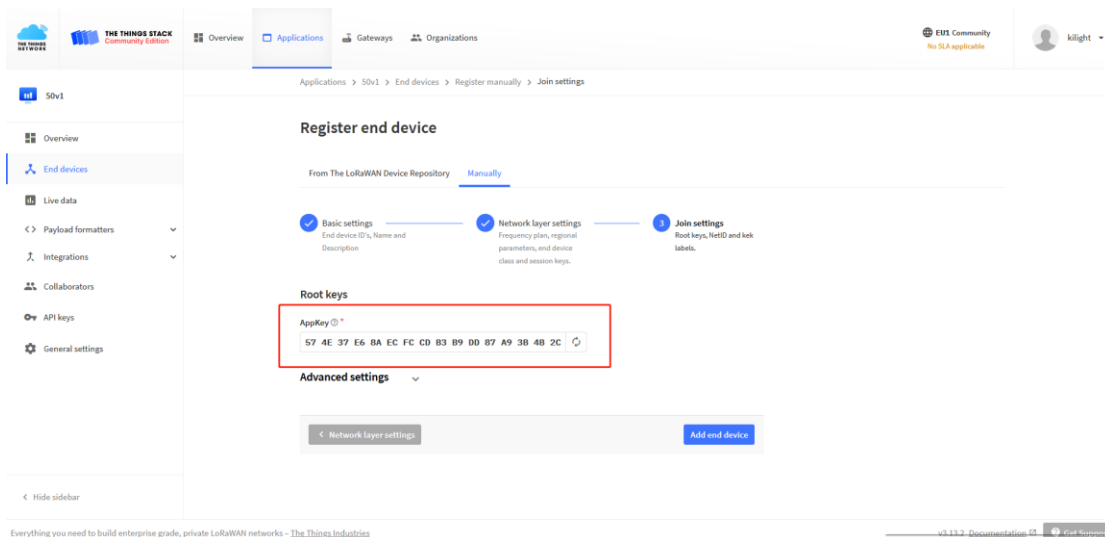

Finally, Application layer settings input the corresponding AppKey. Before saving the configuration, check that the data matches the device.

Step 2: Power on LT-22222-L device and it will automatically join the TTN network. After joining successfully, it will start to upload messages to the TTN v3. Select the Live data tab and you will see the data appearing in the panel.

Note that it may take some time for the device data to appear in the TTN v3 display.

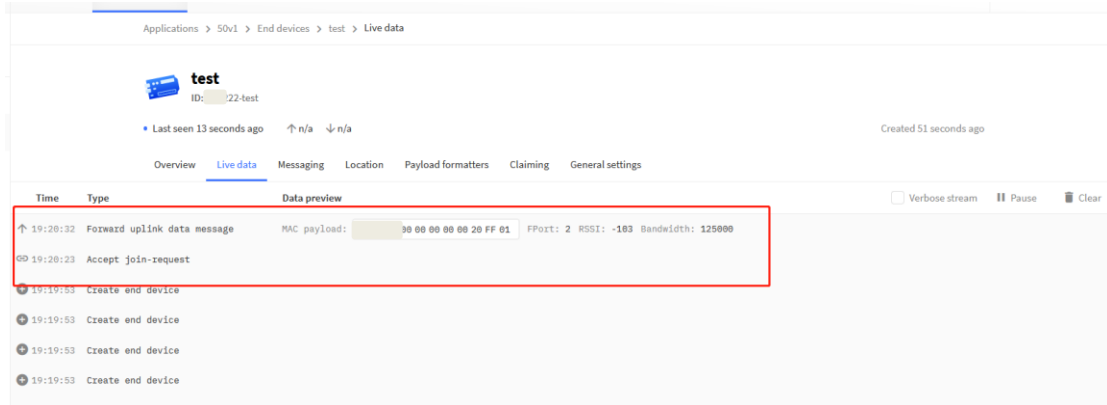

5 Web Configure Pages

5.1 Home

Shows the system running status:

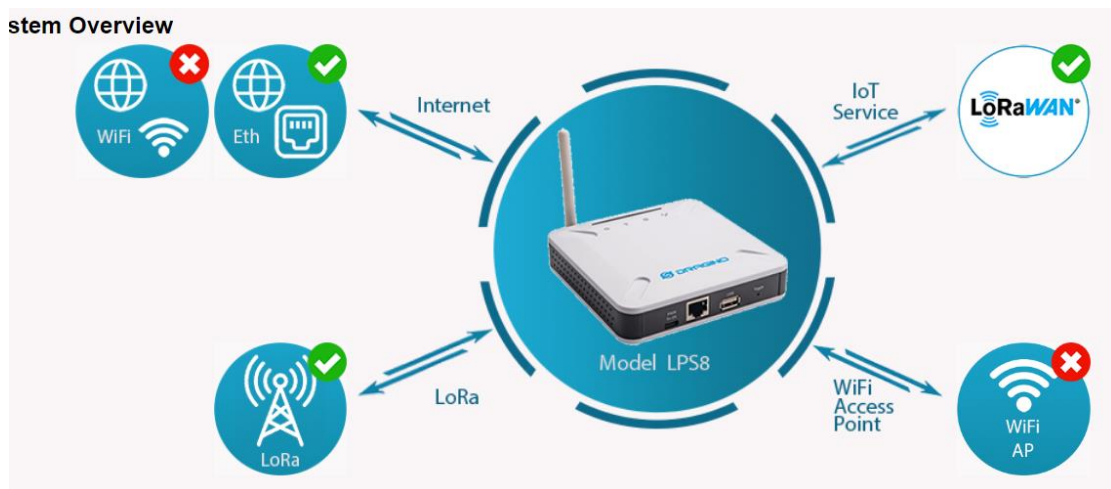

5.2 LoRa Settings

5.2.1 LoRa --> LoRa

This page shows the LoRa Radio Settings. There are a set of default frequency band according to LoRaWAN protocol, and user can customize the band* as well.

Different LPS8 hardware version can support different frequency range:

- **868**: valid frequency: 863Mhz ~ 870Mhz. for bands EU868, RU864, IN865 or KZ865.
- **915**: valid frequency: 902Mhz ~ 928Mhz. for bands US915, AU915, AS923 or KR920

After user choose the frequency plan, he can see the actually frequency in used by checking the page **LogRead --> LoRa Log**

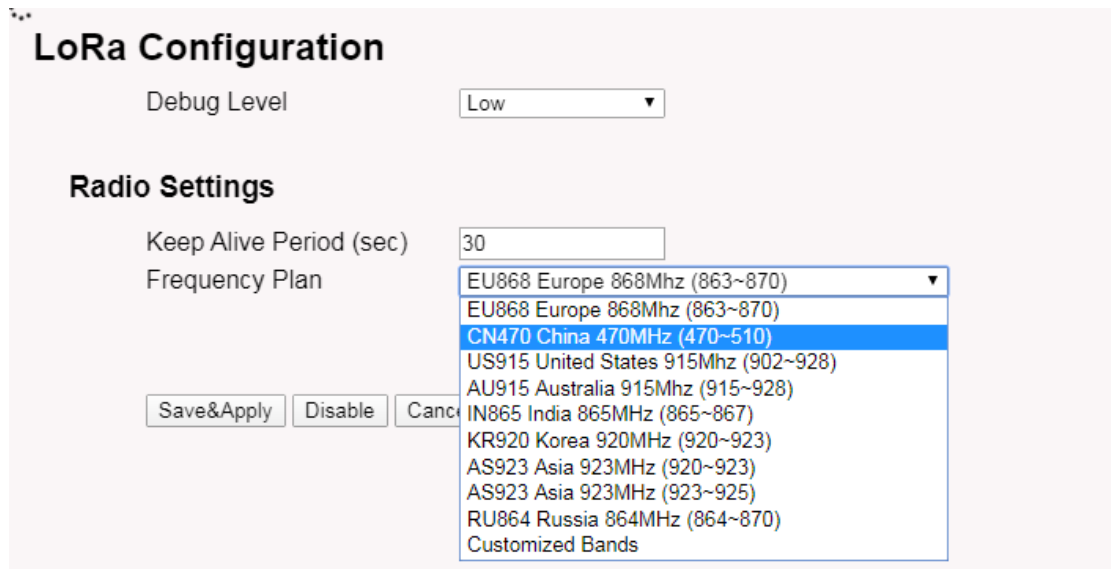

LoRa Configuration

Debug Level

Radio Settings

Keep Alive Period (sec)

Frequency Plan

- EU868 Europe 868Mhz (863~870)
- CN470 China 470MHz (470~510)**
- US915 United States 915Mhz (902~928)
- AU915 Australia 915Mhz (915~928)
- IN865 India 865MHz (865~867)
- KR920 Korea 920MHz (920~923)
- AS923 Asia 923MHz (920~923)
- AS923 Asia 923MHz (923~925)
- RU864 Russia 864MHz (864~870)
- Customized Bands

Note *: See this instruction for how to customize frequency band:

http://wiki.dragino.com/index.php?title=Customized_Frequency_Band_for_Gateway

5.2.2 LoRa --> ABP Decryption

The LPS8 can communicate with LoRaWAN ABP End Node without the need of LoRaWAN server. It can be used in some cases such as:

- No internet connection.
- User wants to get data forward in gateway and forward to their server based on MQTT/HTTP, etc. (Combine ABP communication method and MQTT forward together).

Detail of this feature:

http://wiki.dragino.com/index.php?title=Communication_with_ABP_End_Node

Decrypt ABP End Node Packets

Enable ABP Decryption

Add Key

Dev ADDR:

APP Session Key:

Network Session Key:

Delete Key

Dev ADDR:

ABP Keys:

Dev ADDR | APP Session Key | Network Session Key

5.3 LoRaWAN Settings

5.3.1 LoRaWAN --> LoRaWAN

This page is for the connection set up to a general LoRaWAN Network server such as: [TTN](#), [ChirpStack](#) etc

LoRaWAN Configuration

Server Settings

LoRaWAN Service Provider	<input type="text" value="TTN-router-EU"/>		
Gateway ID	<input type="text" value="a84041ffff1d25dc"/>		
Server Port Upstream	<input type="text" value="1700"/>	Latitude	<input type="text" value="22.705177"/>
Server Port Downstream	<input type="text" value="1700"/>	Longitude	<input type="text" value="114.243423"/>
Email	<input type="text" value="dragino-1d25dc@dragino.com"/>		

Packet Filter

Export Filter

Note

** : Packet filter is to drop the unwanted LoRaWAN packet, instruction see here:

See http://wiki.dragino.com/index.php?title=Main_Page#Filter_unwanted_LoRaWAN_packets

1.1.1 LoRaWAN --> Amazon AWS-IoT

DRAGINO
LoRa ▾ LoRaWAN ▾ MQTT ▾ TCP ▾ Custom Network ▾ System ▾ LogRead ▾

Amazon AWS IoT -- LoRaWAN

Settings

CUPS URI	<input type="text" value="example: https://xxxxxxxx.cups.lorawan.us-east-1.amazonaws.com:443"/>	
Email	<input type="text" value="dragino-1ec39c@dragino.com"/>	
Gateway ID	<input type="text" value="a84041ffff1ec39c"/>	
CUPS trust	Not Found	<input type="button" value="選擇檔案"/> 未選擇任何檔案
Private key	Not Found	<input type="button" value="選擇檔案"/> 未選擇任何檔案
Cert pem	Not Found	<input type="button" value="選擇檔案"/> 未選擇任何檔案

Current Mode: LoRaWAN Semtech UDP Click Save & Apply will change to mode: LoRaWAN Station for AWS

Please see this instruction to know more detail and demo for how to connect to AWS-IoT

LoRaWAN Core: http://wiki.dragino.com/index.php?title=Notes_for_AWS-IoT-Core

5.3.2 LoRaWAN --> LORIIOT

Settings to communicate to LORIIOT LoRaWAN Network Server: <https://www.loriot.io/>

Instruction: http://wiki.dragino.com/index.php?title=Notes_for_LORIIOT

LORIENT Client Configuration

LORIENT software not installed.

Server Address

Server Port

Client Certificate

Client Key

CA File

Device EUI: A840411D25DF

[Certificate Management](#)

5.4 MQTT Settings

If end nodes work in ABP mode, user can configure LPS8 to transfer the data to MQTT broker, Instruction:

http://wiki.dragino.com/index.php?title=Main_Page#MQTT_Forward_Instruction

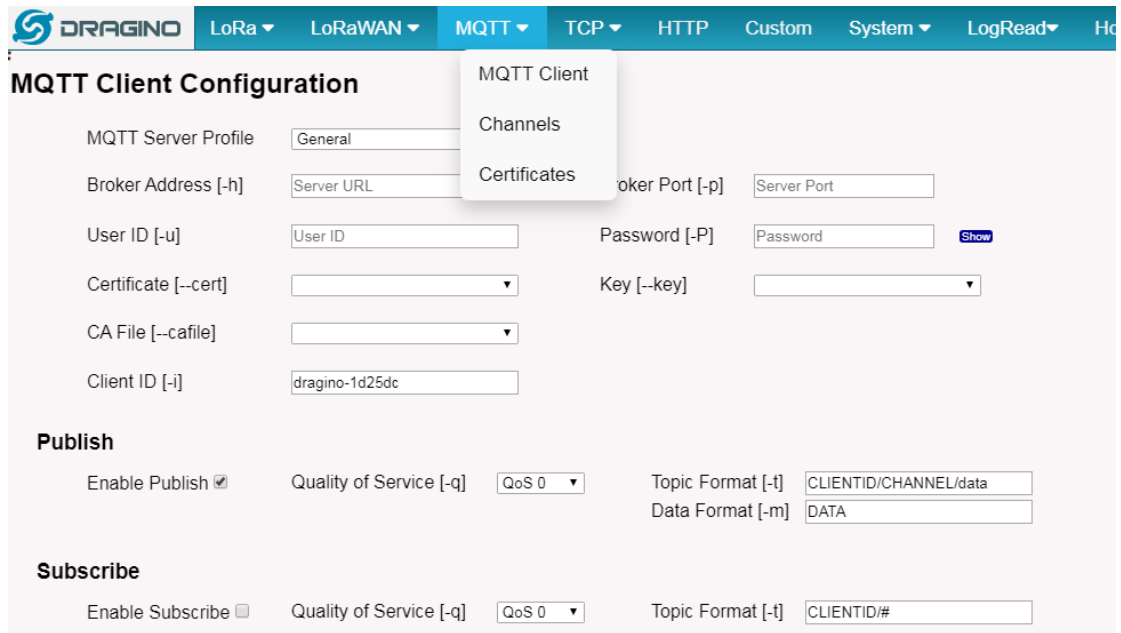

MQTT Client Configuration

MQTT Server Profile: General

Broker Address [-h]: Server URL

MQTT Client: MQTT Client

Broker Port [-p]: Server Port

User ID [-u]: User ID

Password [-P]: Password **Show**

Certificate [--cert]:

Key [--key]:

CA File [--cafile]:

Client ID [-i]: dragino-1d25dc

Publish

Enable Publish

Quality of Service [-q]: QoS 0

Topic Format [-t]: CLIENTID/CHANNEL/data

Data Format [-m]: DATA

Subscribe

Enable Subscribe

Quality of Service [-q]: QoS 0

Topic Format [-t]: CLIENTID/#

5.5 System

5.5.1 System --> System Overview

Shows the system info:

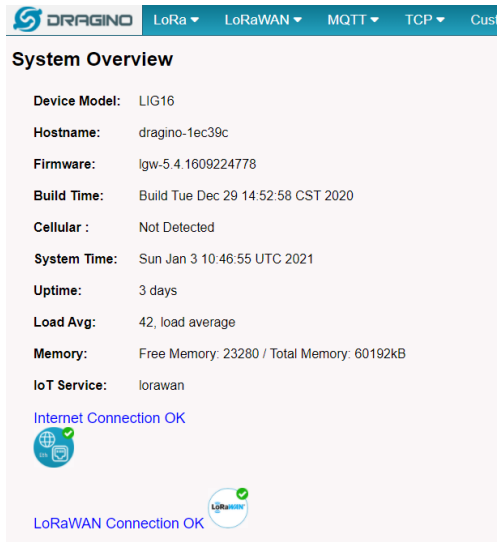

System Overview

- Device Model: LIG16
- Hostname: dragino-1ec39c
- Firmware: lgw-5.4.1609224778
- Build Time: Build Tue Dec 29 14:52:58 CST 2020
- Cellular : Not Detected
- System Time: Sun Jan 3 10:46:55 UTC 2021
- Uptime: 3 days
- Load Avg: 42, load average
- Memory: Free Memory: 23280 / Total Memory: 60192kB
- IoT Service: lorawan
- Internet Connection OK
- LoRaWAN Connection OK

5.5.2 System --> General (login settings)

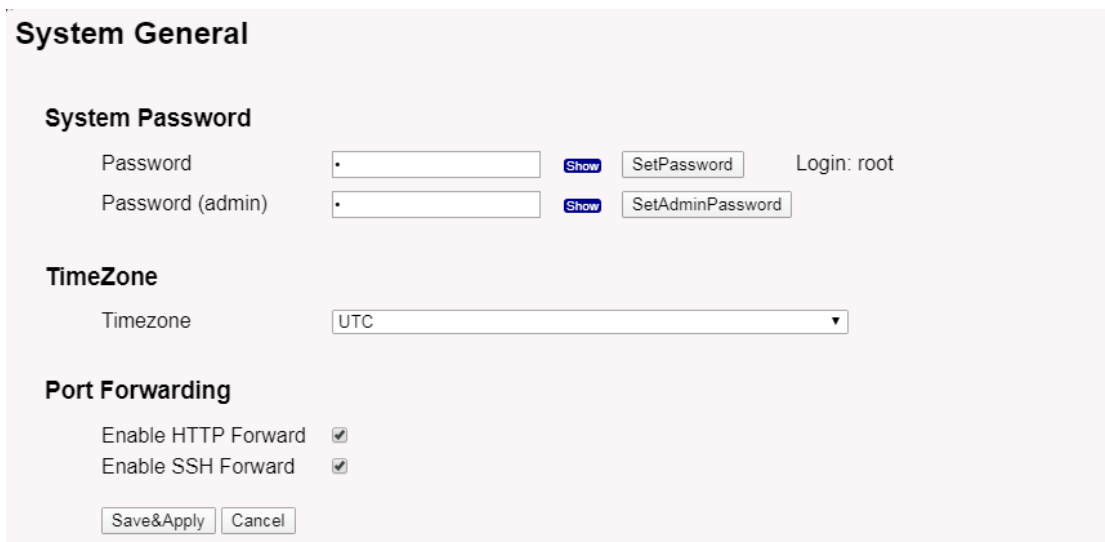

System General

System Password

Password Login: root

Password (admin)

TimeZone

Timezone

Port Forwarding

Enable HTTP Forward

Enable SSH Forward

System Password:

There are two logins for LPS8: **root /dragino** or **admin /dragino**. Both root and admin have the same right for WEB access. But root user has also the right to access via SSH to Linux system. admin only able to access WEB interface.

This page can be used to set the password for them.

Timezone:

Set device timezone.

Port forwarding:

Enable/Disable the HTTP and SSH access via WAN interface.

5.5.3 System --> Network

Network

LAN Settings

IP Address	<input type="text" value="10.130.1.1"/>	Gateway	<input type="text" value="255.255.255.255"/>
Netmask	<input type="text" value="255.255.255.0"/>	DNS	<input type="text" value="8.8.8.8"/>

WAN Settings

Enable DHCP

WiFi WAN Settings

Enable DHCP

LAN Settings:

When the LPS8 has the AP enable, LAN settings specify the network info for LPS8's own network.

WAN Settings:

Setting for LPS8 WAN port

WiFi Settings:

Setting for LPS8 WiFi IP when use it as WiFi Client

5.5.4 System --> WiFi

LPS8 WiFi Settings.

WiFi

Radio Settings

Channel (1-11) Tx Power (0-18) dBm

WiFi Access Point Settings

Enable WiFi Access Point

WiFi Name SSID

Passphrase (8-32 char) [Show](#) Encryption

WiFi WAN Client Settings

Enable WiFi WAN Client

Host WiFi SSID

Passphrase [Show](#) WiFi Survey

Encryption

[Save&Apply](#) [Cancel](#) [Refresh](#)

5.5.5 System --> Network Status

System Status

Network / WiFi Status

```

Network
-----
Lan IP Address:
  inet addr:10.130.1.1 Bcast:10.130.1.255 Mask:255.255.255.0

Eth WAN IP Address:
  inet addr:10.130.2.207 Bcast:10.130.2.255 Mask:255.255.255.0
  inet addr:172.31.255.254 Bcast:172.31.255.255 Mask:255.255.255.252

WiFi WAN IP Address:
Cellular:

Bridge:
bridge name bridge id STP enabled interfaces
br-lan 7fff.a840411d25df no eth0
      wlan0

WiFi
----
wlan0 ESSID: "dragino-1d25dc"
      Access Point: A8:40:41:1D:25:DC
      Mode: Master Channel: 11 (2.462 GHz)
      Tx-Power: 17 dBm Link Quality: unknown/70
      Signal: unknown Noise: -95 dBm
      Bit Rate: unknown
      Encryption: WPA2 PSK (CCMP)
      Type: nl80211 HW Mode(s): 802.11bgn
    
```

5.5.6 System --> Remote Mgmt & Auto Update

Auto Provision is the feature for batch configure and remote management. It can be used in below two cases:

Case 1:
Batch configure gateways before deploy

Local Area Network (LAN)

Gateways

http server with configure files

Case 2:
Maintain gateway configure from cloud

Internet

Gateways

Internet

maintain server with configure files

How it works

Searching and get configure files provision URL

LAN or Internet

1. Gateways search (on every boot or 23:00 every day) the provision URL to get configure files or script files.
2. Gateways compare version number of the configure file, and process update if configure files has higher version.

Auto Provision

Provision Server:

Configure Version: 0

Please see this document for detail:

http://www.dragino.com/downloads/index.php?dir=LoRa_Gateway/LPS8/Firmware/Application_Note/&file=Auto-update-feature.pdf

R-SSH is for remote access device and management, introduction for how to use:

http://wiki.dragino.com/index.php?title=Main_Page#Remote_Access_Gateway_via_Reverse_SSH

R-SSH Host Settings

Login ID

Host Address Host Port

Connect at Startup GWID: a84041ffff1d25dc

Connection Status: **Not connected to RSSH Host**

Note: Auto connection after startup may take up to 5 minutes to clear previous connection

Generate New Keys

Current Key ID: **No keyfile present**

Caution: Generating new keys will break any existing server connections!!

[Download Public Key](#)

5.5.7 System --> Firmware Upgrade

We keep improving the LPS8 firmware for new features and bug fixes. Below are the links for reference.

- **Latest firmware:** [LoRa Gateway Firmware](http://www.dragino.com/downloads/index.php?dir=LoRa_Gateway/LPS8/Firmware),
(http://www.dragino.com/downloads/index.php?dir=LoRa_Gateway/LPS8/Firmware)
- **Change Log:** [Firmware Change Log](http://www.dragino.com/downloads/downloads/LoRa_Gateway/LPS8/Firmware/ChangeLog).
(http://www.dragino.com/downloads/downloads/LoRa_Gateway/LPS8/Firmware/ChangeLog)

The file named as **dragino-igw-xxxxx-squashfs-sysupgrade.bin** is the upgrade Image. as below.

Web → System → Firmware Upgrade

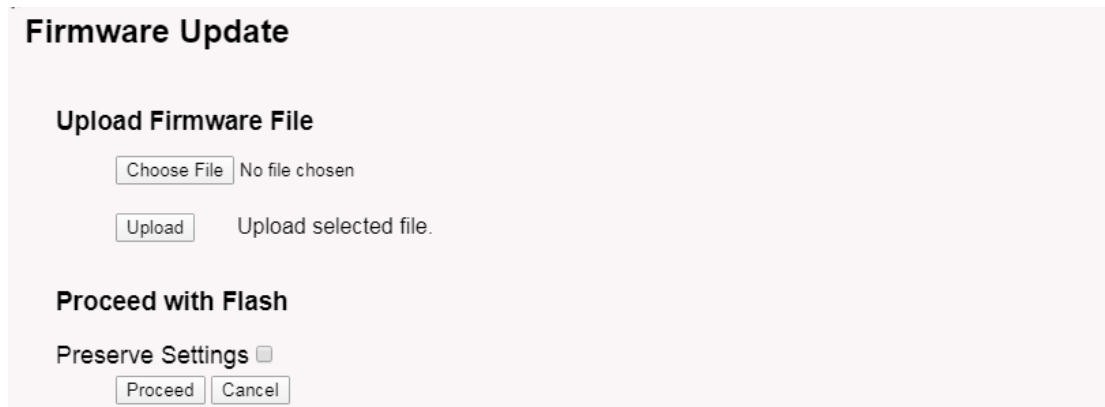

The screenshot shows a web interface for firmware updates. It has a title 'Firmware Update' and two main sections. The first section, 'Upload Firmware File', contains a 'Choose File' button next to the text 'No file chosen', and an 'Upload' button next to the text 'Upload selected file.'. The second section, 'Proceed with Flash', contains a 'Preserve Settings' checkbox which is currently unchecked, and two buttons: 'Proceed' and 'Cancel'.

Select the required image and click **Upload**. The image will be uploaded to the device, and then click **Process** to upgrade.

NOTE: You normally need to **uncheck** the **Preserve Settings** checkbox when doing an upgrade to ensure that there is no conflict between the old settings and the new firmware. The new firmware will start up with its default settings.

The system will automatically boot into the new firmware after upgrade.

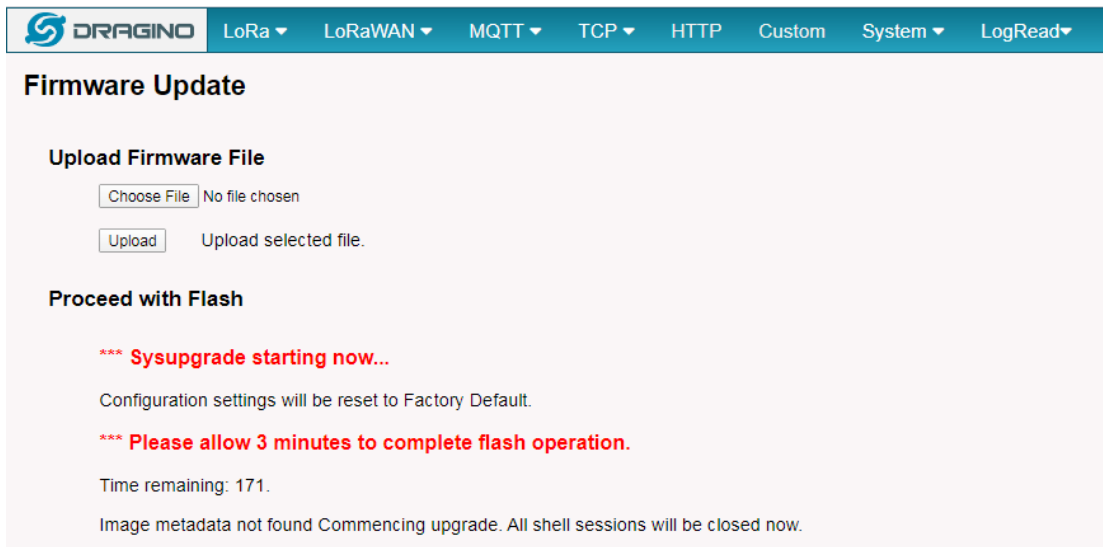

Firmware Update

Upload Firmware File

No file chosen

Upload selected file.

Proceed with Flash

***** Sysupgrade starting now...**

Configuration settings will be reset to Factory Default.

***** Please allow 3 minutes to complete flash operation.**

Time remaining: 171.

Image metadata not found Commencing upgrade. All shell sessions will be closed now.

Note *: User can also upgrade firmware via Linux console

SCP the firmware to the system **/var** directory and then run

```
root@OpenWrt:~# /sbin/sysupgrade -n /var/Your_Image
```

NOTE: it is important to transfer the image in the **/var** directory, otherwise it may exceed the available flash size.

5.5.8 System --> Reboot/Reset

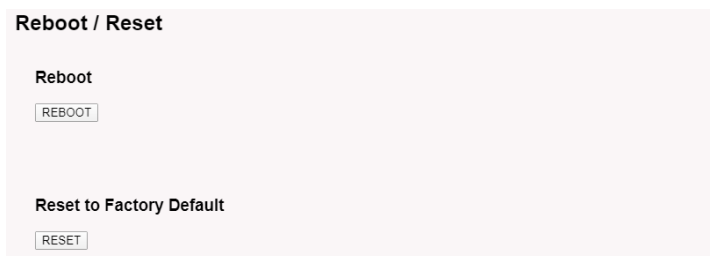

Reboot / Reset

Reboot

Reset to Factory Default

5.5.9 System --> Package Maintain

Package Management

Package List

Package data is not loaded. Click on Reload to download package data.

Click Reload to download package list. This will take a while.

Installed Package List

```
atftp - 0.7.1-5
base-files - 190-r5-ce45a50
bikid - 2.32-2
block-mount - 2018-04-16-e2436836-1
busybox - 1.28.3-4
ca-certificates - 20180409
dhcpcd - 7.4.2-1.2
```

Place to show what packages have been installed and possible to upgrade packages.

6 More features

6.1 Packet Filtering

Drop unwanted packets:

See http://wiki.dragino.com/index.php?title=Main_Page#Filter_unwanted_LoRaWAN_packets

6.2 Remote Access

Remote Access Devices for management:

Instruction

http://wiki.dragino.com/index.php?title=Main_Page#Remote_Access_Gateway_via_Reverse_SSH

6.3 How to decode ABP LoRaWAN node

Decode ABP

http://wiki.dragino.com/index.php?title=Communication_with_ABP_End_Node

6.4 How to set data to MQTT broker

Only support ABP LoRaWAN End Node

Instruction:

http://wiki.dragino.com/index.php?title=Main_Page#MQTT_Forward_Instruction

6.5 More instructions

http://wiki.dragino.com/index.php?title=Main_Page#LoRa.2FLoRaWAN_Gateway_Instruction

6.6 Auto-Provision

Auto Provision is the feature for batch configure and remote management. It can be used in below two cases:

Case 1:
Batch configure gateways before deploy

Local Area Network (LAN)

Gateways

http server with configure files

Case 2:
Maintain gateway configure from cloud

Internet

Gateways

Internet

maintain server with configure files

How it works

Searching and get configure files provision URL

LAN or Internet

1. Gateways search (on every boot or 23:00 every day) the provision URL to get configure files or script files.
2. Gateways compare version number of the configure file, and process update if configure files has higher version.

Auto Provision

Provision Server:

Configure Version: 0

Please see this document for detail:

http://www.dragino.com/downloads/index.php?dir=LoRa_Gateway/LPS8/Firmware/Application_Note/&file=Auto-update-feature.pdf

7 Linux System

The LPS8 is based on the OpenWrt Linux system. It is open source, and users are free to configure and modify the Linux settings.

7.1 SSH Access for Linux console

User can access the Linux console via the SSH protocol. Make sure your PC and the LPS8 are connected to the same network, then use a SSH tool (such as [putty](#) in Windows) to access it.

IP address: IP address of LPS8

Port: 22 or 2222 (SSH port in WAN interface has been change to 2222 since firmware 5.3.xx, for security reason)

User Name: **root**

Password: **dragino** (default)

After logging in, you will be in the Linux console and can enter commands as shown below.

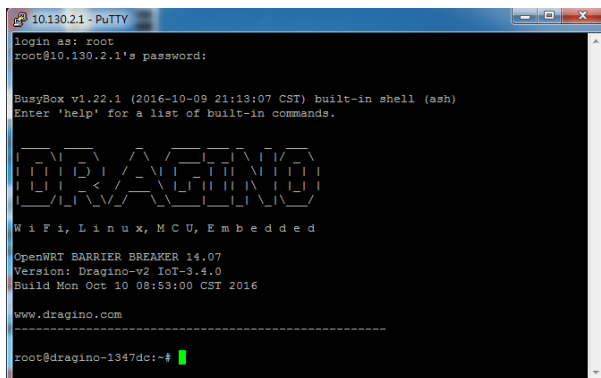

The “logread -f” command can be used to debug how system runs.

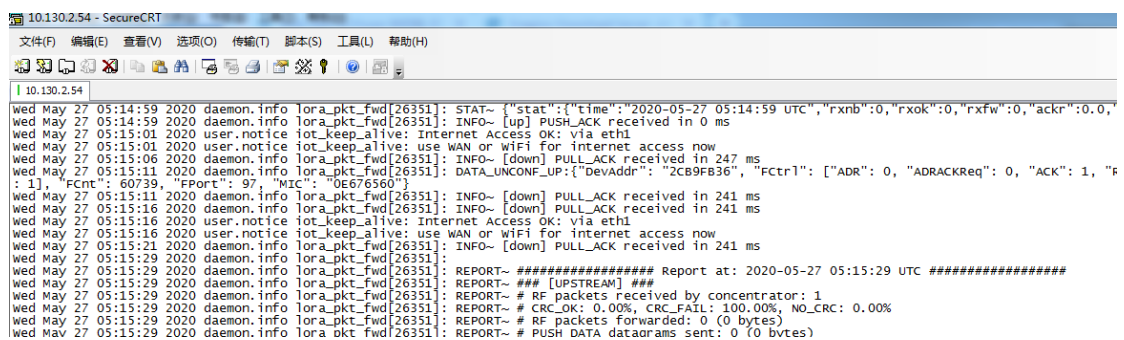

7.2 Edit and Transfer files

The LPS8 supports the **SCP protocol** and has a built-in **SFTP server**. There are many ways to edit and transfer files using these protocols.

In Windows, one of the easiest methods is using the [WinSCP](#) utility.

After establishing access via WinSCP to the device, you can use an FTP style window to drag / drop files to the LPS8, or edit the files directly in the windows.

Screenshot is as below:

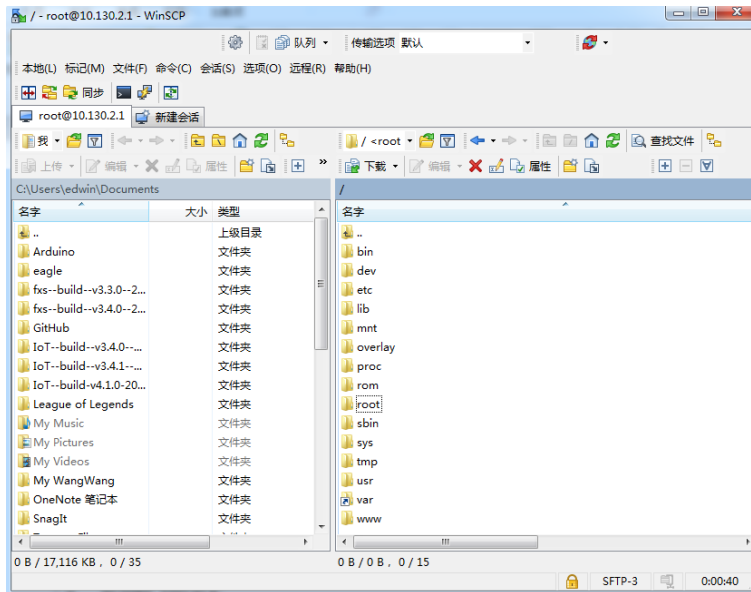

7.3 File System

The LPS8 has a 16MB flash and a 64MB RAM. The /var and /tmp directories are in the RAM, so contents stored in /tmp and /var will be erased after rebooting the device. Other directories are in the flash and will remain after reboot.

The Linux system uses around 8MB ~10MB flash size which means there is not much room for user to store data in the LPS8 flash.

You can use an external USB flash memory device to extend the size of flash memory for storage.

7.4 Package maintenance system

LPS8 uses the OpenWrt [OPKG package maintenance system](#). There are more than 3000+ packages available in our package server for users to install for their applications. For example, if you want to add the *iperf* tool, you can install the related packages and configure LPS8 to use *iperf*.

Below are some example *opkg* commands. For more information please refer to the [OPKG package maintain system](#) (<https://wiki.openwrt.org/doc/techref/opkg>)

In Linux Console run:

```
root@dragino-169d30:~# opkg update // to get the latest packages list
```

```
root@dragino-169d30:~# opkg list //shows the available packages
```

```
root@dragino-169d30:~# opkg install iperf // install iperf
```

The system will automatically install the required packages as shown below.

```
root@dragino-169d30:/etc/opkg# opkg install iperf
```

```
Installing iperf (2.0.12-1) to root...
```

```
Downloading http://downloads.openwrt.org/snapshots/packages/mips\_24kc/base/iperf\_2.0.12-1\_mips\_24kc.ipk
```

```
Installing uclibcxx (0.2.4-3) to root...
```

```
Downloading http://downloads.openwrt.org/snapshots/packages/mips\_24kc/base/uclibcxx\_0.2.4-
```

```
3\_mips\_24kc.ipk
```

```
Configuring uclibcxx.
```

```
Configuring iperf.
```

8 Upgrade Linux Firmware

We keep improving the LPS8 Linux side firmware for new features and bug fixes. Below are the links for reference.

- **Latest firmware:** [LoRa Gateway Firmware](http://www.dragino.com/downloads/index.php?dir=LoRa_Gateway/LG02-OLG02/Firmware),
(http://www.dragino.com/downloads/index.php?dir=LoRa_Gateway/LG02-OLG02/Firmware)
- **Change Log:** [Firmware Change Log](http://www.dragino.com/downloads/downloads/LoRa_Gateway/LG02-OLG02/Firmware/ChangeLog).
(http://www.dragino.com/downloads/downloads/LoRa_Gateway/LG02-OLG02/Firmware/ChangeLog)

The file named as **xxxxx-xxxxx-squashfs-sysupgrade.bin** is the upgrade Image. There are different methods to upgrade, as below.

8.1 Upgrade via Web UI

Go to the page: **Web → System → Firmware Upgrade**

Select the required image and click **Flash Image**. The image will be uploaded to the device, and then click **Process Update** to upgrade.

NOTE: You normally need to **uncheck** the **Preserve Settings** checkbox when doing an upgrade to ensure that there is no conflict between the old settings and the new firmware. The new firmware will start up with its default settings.

The system will automatically boot into the new firmware after upgrade.

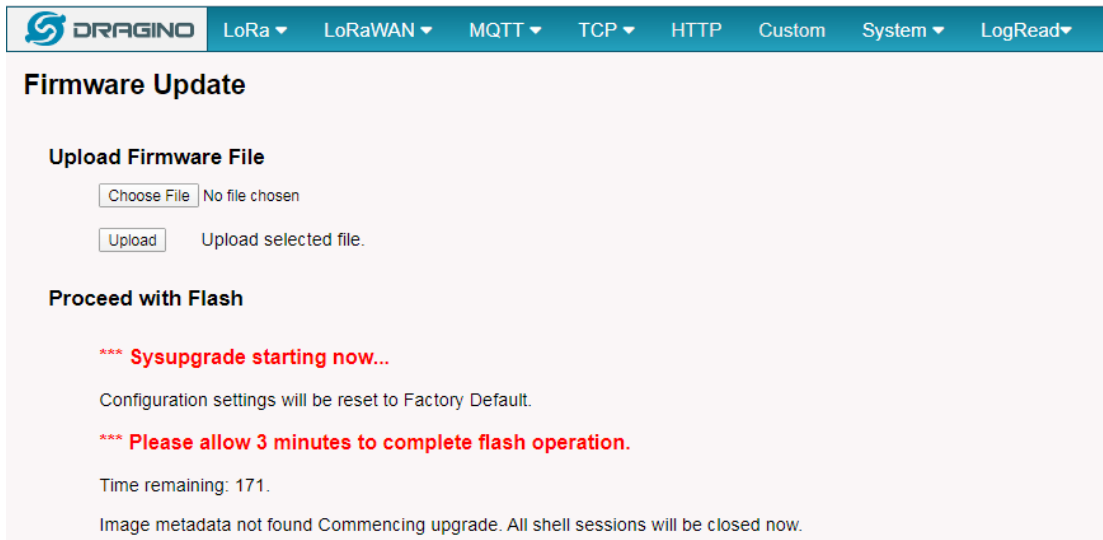

8.2 Upgrade via Linux console

SCP the firmware to the system `/var` directory and then run

```
root@OpenWrt:~# /sbin/sysupgrade -n /var/Your_Image
```

NOTE: it is important to transfer the image in the `/var` directory, otherwise it may exceed the available flash size.

9 FAQ

9.1 How can I configure for a customized frequency band?

See below link for how to customize frequency band:

http://wiki.dragino.com/index.php?title=Customized_Frequency_Band_for_Gateway

9.2 Can I make my own firmware for the gateway, Where can I find the source code?

Yes, You can make your own firmware for the LPS8 for branding purposes or to add customized applications.

The source code and compile instructions can be found at:

https://github.com/dragino/openwrt_lede-18.06

9.3 Can I use 868Mhz version for 915Mhz bands?

It is possible but the distance will be very short, you can select US915 frequency band in 868Mhz version hardware. It will work but you will see the performance is greatly decreased because the 868Mhz version has an RF filter for band 863~870Mhz, all other frequencies will have high attenuation.

10 Trouble Shooting

10.1 I get kernel error when install new package, how to fix?

In some cases, when installing a package with *opkg*, it will generate a kernel error such as below due to a mismatch I the kernel ID:

```
root@dragino-16c538:~# opkg install kmod-dragino2-si3217x_3.10.49+0.2-1_ar71xx.ipk
Installing kmod-dragino2-si3217x (3.10.49+0.2-1) to root...
Collected errors:
* satisfy_dependencies_for: Cannot satisfy the following dependencies for kmod-dragino2-si3217x:
* kernel (= 3.10.49-1-4917516478a753314254643facdf360a) *
* opkg_install_cmd: Cannot install package kmod-dragino2-si3217x.
```

In this case, you can use the `-force-depends` option to install such package as long as the actual kernel version is the same.

```
Opkg install kmod-dragino2-si3217x_3.10.49+0.2-1_ar71xx.ipk -force-depends
```

10.2 How to recover the LPS8 if the firmware crashes

Please follow this instruction to recover your gateway:

http://wiki.dragino.com/index.php?title=Recover_Gateway

10.3 I configured LPS8 for WiFi access and lost its IP. What to do now?

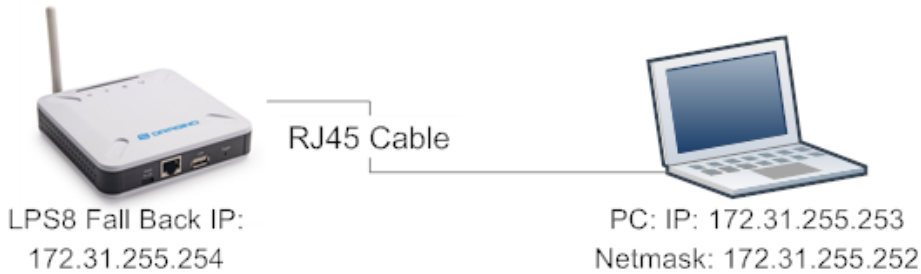

The LPS8 has a fall-back IP address on its WAN port. This IP is always enabled so you can use the fall-back IP to access LPS8 no matter what the WiFi IP is. The fall back IP is useful for connecting and debug the unit.

(Note: fallback IP can be disabled in the WAN and DHCP page)

Steps to connect via fall back IP:

1. Connect PC's Ethernet port to LG01's WAN port
2. Configure PC's Ethernet port has
IP: 172.31.255.253 and
Netmask: 255.255.255.252

As below photo:

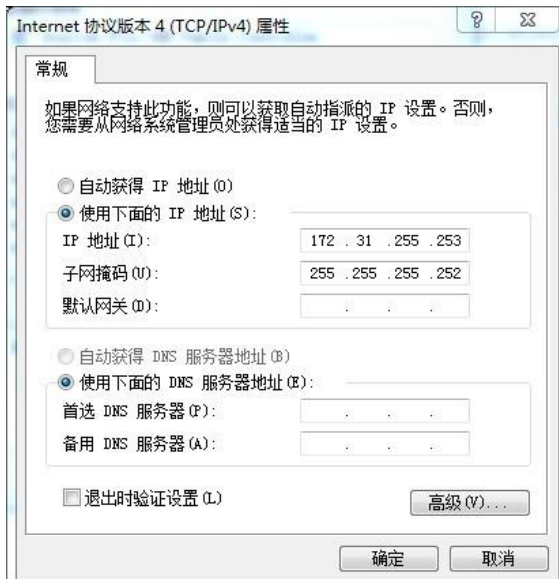

3. In the PC, use IP address 172.31.255.254 to access the LPS8 via Web or Console. Please note the latest firmware uses port 8000 for http and 2222 for ssh access.

10.4 I connect to the LPS8's SSID but LPS8 didn't assign DHCP IP to my laptop?

This is a known bug for the firmware version before 2019-09-23 for LPS, the issue was fixed since version: LG02_LG08--build-v5.2.1569218466-20190923-1402.

In the old version, user can use the [fall back ip method](#) to access and configure the device.

11 Order Info

PART: LPS8-XXX-YYY:

XXX: Frequency Band

- **868**: valid frequency: 863Mhz ~ 870Mhz. for bands EU868, RU864, IN865 or KZ865.
- **915**: valid frequency: 902Mhz ~ 928Mhz. for bands US915, AU915, AS923 or KR920

12 Packing Info

Package Includes:

- ✓ LPS8 LoRaWAN Gateway x 1
- ✓ Stick Antenna for LoRa RF part. Frequency is one of 470 or 868 or 915Mhz depends the model ordered
- ✓ Packaging with environmental protection paper box

Dimension and weight:

- ✓ Device Size: 12 x 12 x 3 cm
- ✓ Weight: 187g
- ✓ Package Size: 14.5 x 13.5 x 6 cm
- ✓ Weight: 300g

13 Support

- Try to see if your questions already answered in the [wiki](#).
- Support is provided Monday to Friday, from 09:00 to 18:00 GMT+8.
Due to different timezones we cannot offer live support. However, your questions will be answered as soon as possible in the before mentioned schedule.
- Provide as much information as possible regarding your enquiry (product models, accurately describe your problem and steps to replicate it etc) and send a mail to:

support@dragino.com

14 FCC Warning

This device complies with part 15 of the FCC Rules. Operation is subject to the following two conditions:

- (1) This device may not cause harmful interference, and
- (2) this device must accept any interference received, including interference that may cause undesired operation