

End feed and couplers
Standard

Einspeiser und Verbinder
Standard

EUTRAC®

3~

**3 Circuit (230V)
Tracks and Adaptors**

**3 Phasen (230V)
Stromschienen und Adaptern**

www.EUTRAC.com

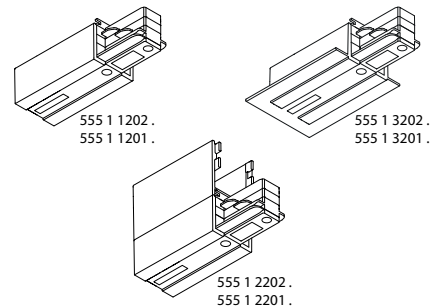

Essential safety Informations

- This product is suitable for EUTRAC 3-circuit track systems only.
- This product is for indoor use only (IP20, 45°C max.) , do not use in damp or wet locations.
- **Mains voltage must be switched off before mounting, maintenance, insert or replacement of end feed and couplers.**
- The track system must be installed and maintained by a suitably qualified person in compliance with latest installation and safety regulations.
- Installation and operating of these live ends and couplers are subject to national safety regulations.
The manufacturer is not liable for damage caused by improper use or installation.
If any live end or coupler is subsequently modified, the person responsible for the modification shall be considered as manufacturer.
- Material used for ceiling fixation should be conform to the relevant building regulation
- It is the responsibility of the installer to ensure the electrical, mechanical and thermal compatibility of the track system and the fittings.
- Technical amendments and graphical presentation are subject to change.
- **Save these instructions.**

Sicherheitshinweise

English

Deutsch

- Dieses Produkt ist nur zum Einsatz in EUTRAC 3-Phasen Stromschienen-Systeme geeignet.
- Dieses Produkt ist nur für die Anwendung im trockenen Innenraum IP20 (max. 45°C) zugelassen. Feuchträume und Nasszellen sind hiervon ausgeschlossen.
- **Es ist zwingend notwendig, vor Beginn jeder Installation, Überprüfung, Wartung, Einsetzen oder Austauschen von Einspeisern und Verbindern die Netzspannung zu unterbrechen.**
- Montage und Wartung darf nur von geschultem Fachpersonal mit entsprechender beruflicher Qualifikation in Übereinstimmung mit den neuesten elektrischen Installations und Sicherheitsvorschriften durchgeführt werden.
- Für die Installation und für den Betrieb dieser Einspeiser und Verbinder sind die nationalen Sicherheitsvorschriften zu beachten.
Der Hersteller übernimmt keine Haftung für Schäden, die durch unsachgemäßen Einsatz oder Montage entstehen.
Werden nachträglich Änderungen an den Einspeisern und Verbindern vorgenommen, so gilt derjenige als Hersteller, der diese Änderungen vornimmt.
- Im Deckenbereich ist nur baupolizeilich zugelassenes Befestigungsmaterial zu verwenden.
- Es liegt im Verantwortungsbereich des Installateurs, die elektrische, mechanische und thermische Verträglichkeit zwischen dem Stromschienensystem und den daran angebrachten Strahlern und Leuchten sicherzustellen.
- Technische und grafische Änderungen vorbehalten.
- **Montageanleitung aufbewahren.**

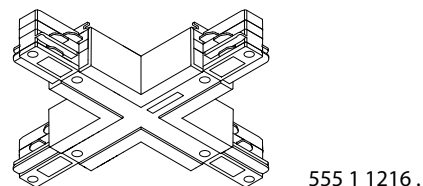
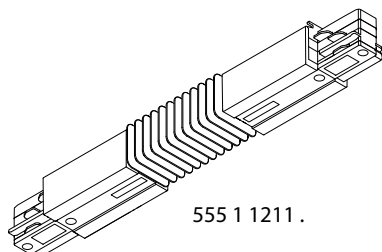
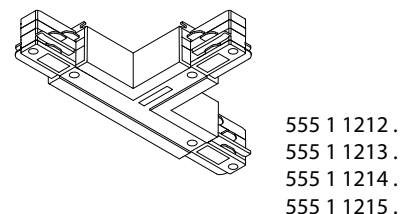
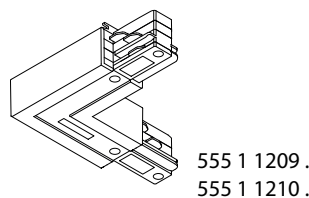
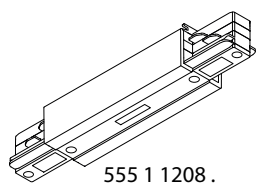
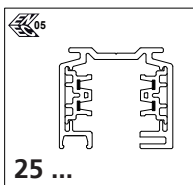

End feed and couplers
Standard

Einspeiser und Verbinder
Standard

EUTRAC®

3~

**3 Circuit (230V)
Tracks and Adaptors**

**3 Phasen (230V)
Stromschienen und Adaptern**

www.EUTRAC.com

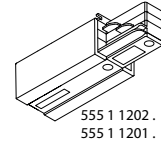

555 1 1202 .
555 1 1201 .

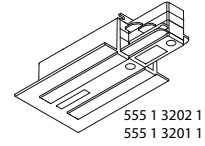

555 1 3202 1
555 1 3201 1

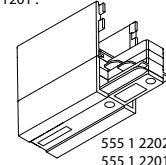

555 1 2202 .
555 1 2201 .

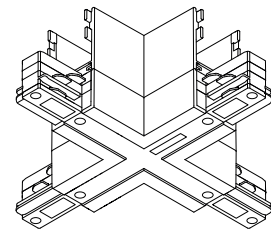
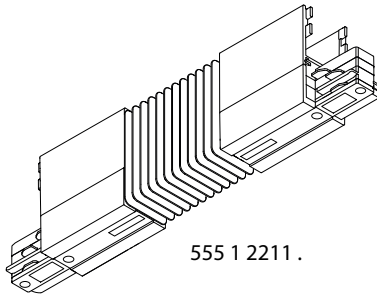
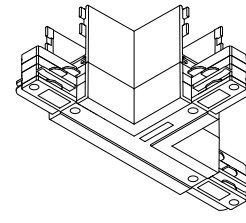
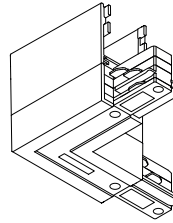
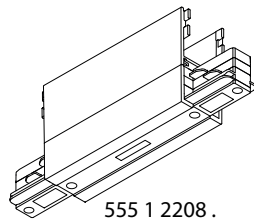
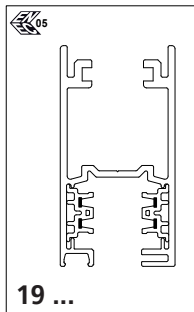
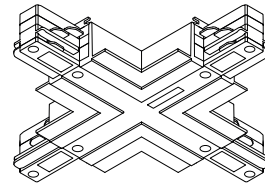
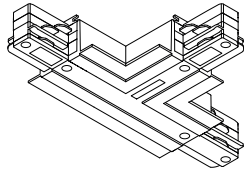
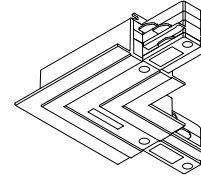
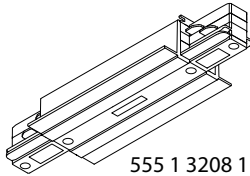
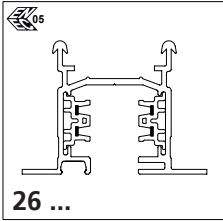

End feed and couplers
Standard

Einspeiser und Verbinder
Standard

EUTRAC® 3~

**3 Circuit (230V)
Tracks and Adaptors**

**3 Phasen (230V)
Stromschienen und Adaptern**

www.EUTRAC.com

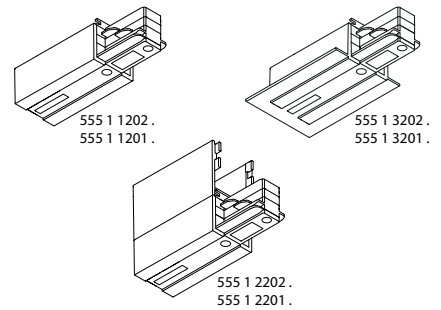

1 - Feed from the top:
- Einspeisung von oben:

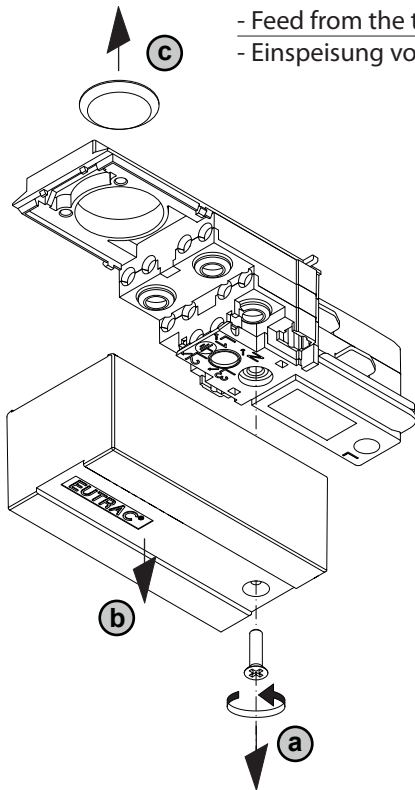

2 - Example : 555 1 1202
- Beispiel : 555 1 1202

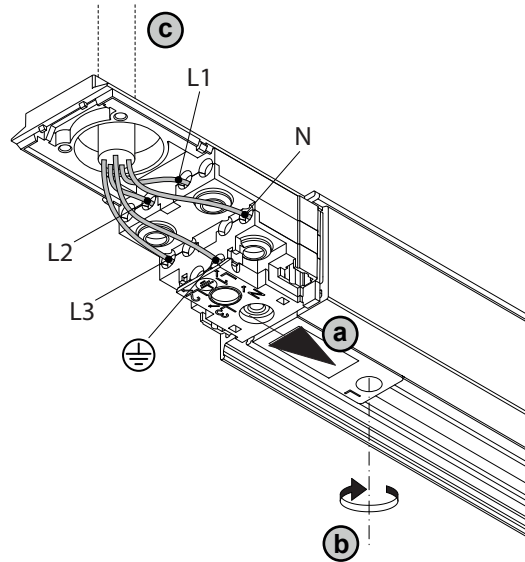

1 -Optional - Feed from the side:
- Einspeisung von der Seite:

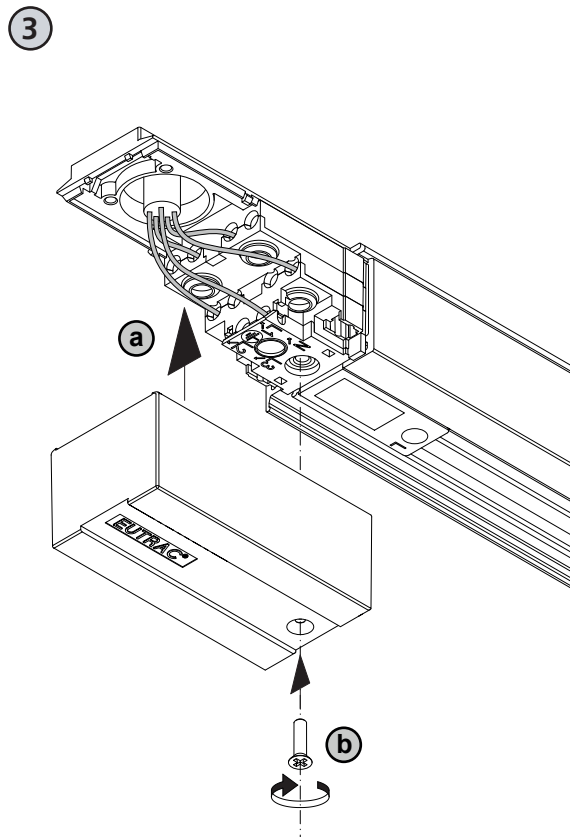
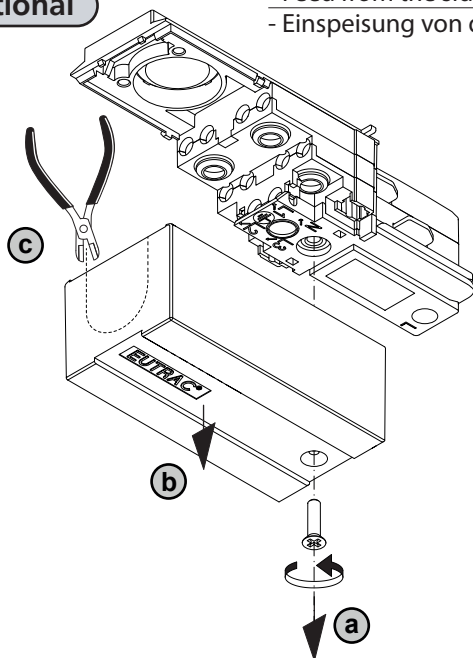

End feed and couplers
Standard

Einspeiser und Verbinder
Standard

EUTRAC®

3~

**3 Circuit (230V)
Tracks and Adaptors**

**3 Phasen (230V)
Stromschienen und Adaptern**

www.EUTRAC.com

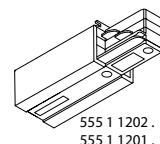

555 1 1202.
555 1 1201.

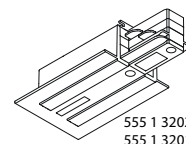

555 1 3202.1
555 1 3201.1

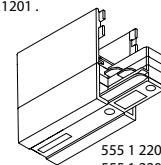

555 1 2202.
555 1 2201.

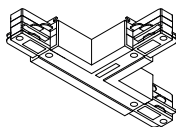

555 1 1212.

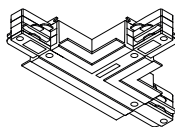

555 1 3212.1

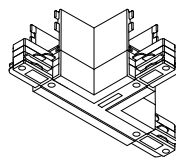

555 1 2212.

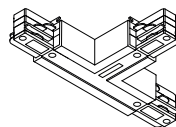

555 1 1213.

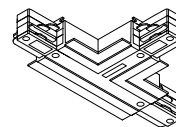

555 1 3213.1

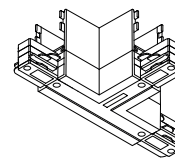

555 1 2213.

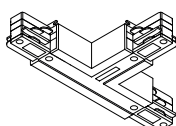
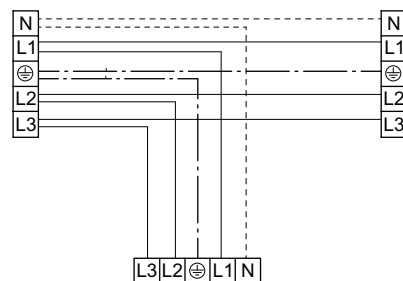
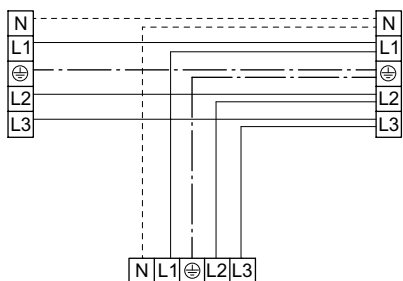

555 1 1214.

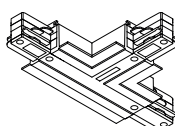

555 1 2214.

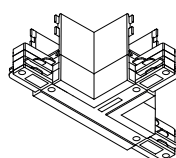

555 1 3214.1

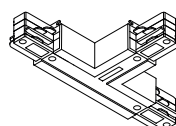

555 1 1215.

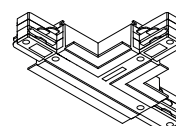

555 1 2215.

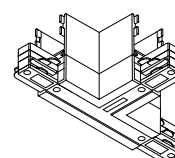

555 1 3215.1

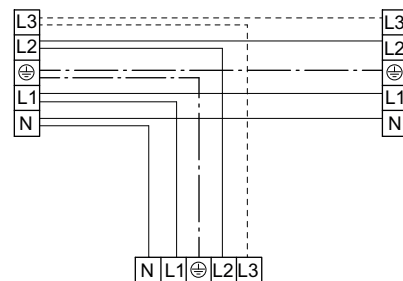
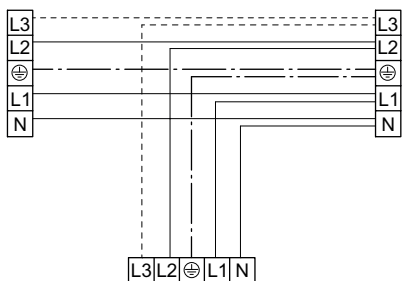

· ASSEMBLY INSTRUCTIONS · MONTAGEANLEITUNG ·

End feed and couplers
Standard

Einspeiser und Verbinder
Standard

EUTRAC®

3~

**3 Circuit (230V)
Tracks and Adaptors**

**3 Phasen (230V)
Stromschienen und Adaptern**

www.EUTRAC.com

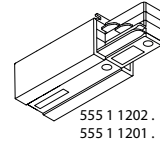

555 1 1202 .
555 1 1201 .

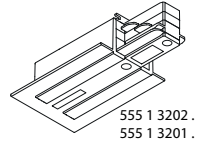

555 1 3202 .
555 1 3201 .

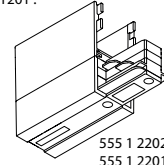

555 1 2202 .
555 1 2201 .

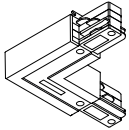

555 1 1209 .

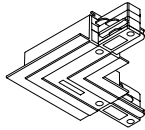

555 1 3209 1

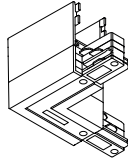

555 1 2209 .

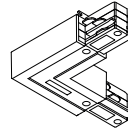

555 1 1210 .

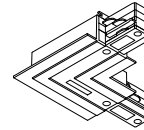

555 1 3210 1

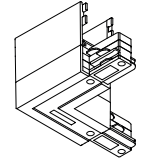

555 1 2210 .

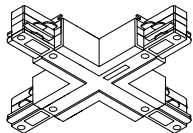
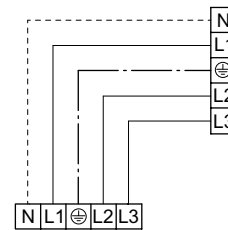
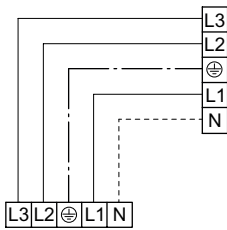

555 1 1216 .

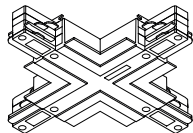

555 1 3216 1

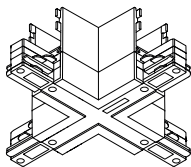

555 1 2216 .

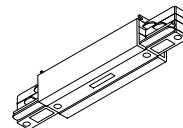
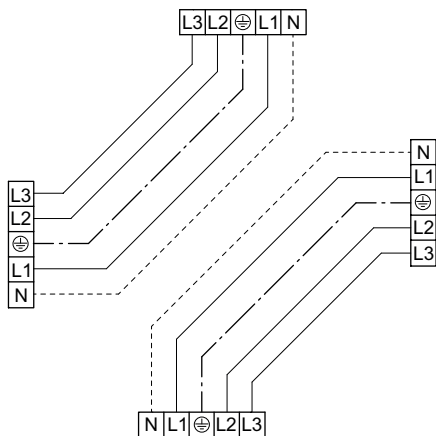

555 1 1208 .

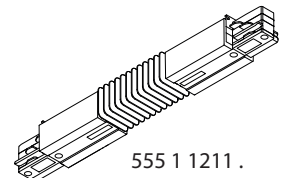

555 1 1211 .

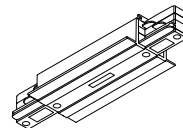

555 1 3208 1

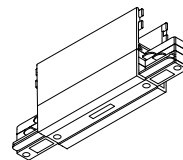

555 1 1208 .

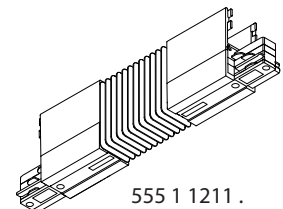

555 1 1211 .

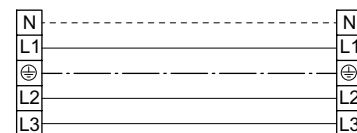

07.12.2012

Page/Seite 5/6

514326

MT 6.175/2

End feed and couplers
Standard

Einspeiser und Verbinder
Standard

EUTRAC®

3~

**3 Circuit (230V)
Tracks and Adaptors**

**3 Phasen (230V)
Stromschienen und Adaptern**

www.EUTRAC.com

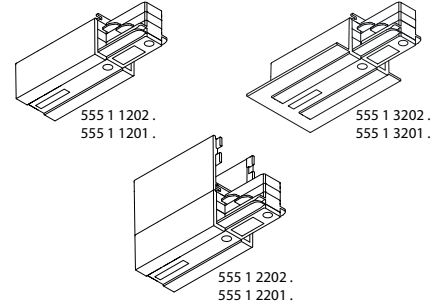

3~ track wiring diagram

a) Connection to AC 230V (220 - 240V)

maximum load: 3.600 W (3.500 - 3.800 W)

Total load can spread on any circuit

fuse 1 x 16 A

power supply cable min. 3 x 1.5 mm² / max. 3 x 2.5 mm²

3~ Schiene Anschlusschema

a) Anschluss am Wechselstromnetz 230V (220-240V)

Höchstbelastung: 3.600 W (3.500 - 3.800 W)

Gesamtbelastung kann beliebig auf 3 Stromkreise verteilt werden.

Absicherung 1 x 16 A

Zuleitung min. 3 x 1,5 mm² / max. 3 x 2,5 mm²

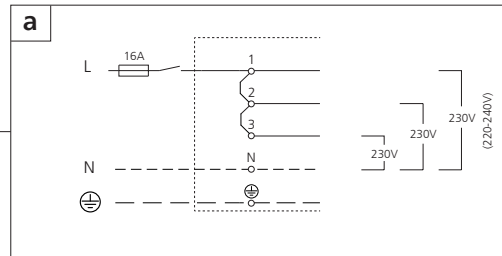

3~ track wiring diagram

a) Connection to AC 230V (220 - 240V)

maximum load: 3.600 W (3.500 - 3.800 W)

Total load can spread on any circuit

fuse 1 x 16 A

power supply cable min. 5 x 1.5 mm² / max. 5 x 2.5 mm²

3~ Schiene Anschlusschema

a) Anschluss am Wechselstromnetz 230V (220-240V)

Höchstbelastung: 3.600 W (3.500 - 3.800 W)

Gesamtbelastung kann beliebig auf 3 Stromkreise verteilt werden.

Absicherung 1 x 16 A

Zuleitung min. 5 x 1,5 mm² / max. 5 x 2,5 mm²

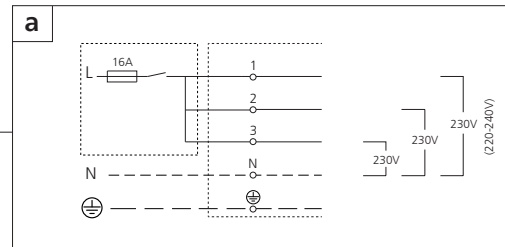

b) Connection to AC 400V (380 - 415V)

maximum load: 3 x 3.600 W = 10.800 W (11.400 W)

Single fuse for each circuit, look for even spread L₁, L₂, L₃ of total load

fuse 3 x 16 A

power supply cable min. 5 x 1.5 mm² / max. 5 x 2.5 mm²

Load at end feed: All end feeds can be loaded as shown under a) or b)

b) Anschluss am Drehstromnetz 400V (380-415V)

Höchstbelastung: 3 x 3.600 W = 10.800 W (11.400 W)

Einzelabsicherung aller drei Phasen, auf gleichmäßige Lastverteilung der einzelnen Phasen L₁, L₂, L₃ achten.

Absicherung 3 x 16 A

Zuleitung min. 5 x 1,5 mm² / max. 5 x 2,5 mm²

Belastbarkeit der Einspeiser:

Alle Einspeiser sind gemäß Daten nach a) und b) belastbar

