

# HCB-6000

1080p Analog HD Camera



## Key Features

- Full HD resolution
- 0.09 Lux@F1.2 (Color), 0.009 Lux@F1.2 (B/W )
- Day & Night (ICR), WDR (120dB)
- SSNRIV, Motion detection
- Transmission distance max.500m
- Easy Installation (Plug & play), Dual power, RS-485

## Accessories (Optional)



SLA-M2890DN



SHB-4300H



SHB-4300H2



SHB-4300H1



SHB-4200



SHB-4200H



SLA-M2890PN



SLA-M3180DN

<b>Video</b>	
Imaging Device	1/2.8" 2MP CMOS
Effective Pixels	1945(H)x1097(V)
Min. Illumination	Color: 0.09Lux(F1.2, 1/30sec) BW: 0.009Lux(F1.2, 1/30sec)
Video Out	BNC(AHD / TVI / CVI / CVBS Selectable)
<b>Lens</b>	
Focus Control	Manual
Lens Type	DC auto iris
Mount Type	C mount, CS mount
<b>Operational</b>	
Camera Title	Displayed up to 15 characters
Day & Night	Auto(ICR)
Backlight Compensation	BLC, HLC, WDR
Wide Dynamic Range	120dB
Digital Noise Reduction	SSNRIV
Defog	Support
Motion Detection	4ea
Privacy Masking	8ea, rectangular zones
Gain Control	Low / Middle / High / Very High
White Balance	ATW / AWC / Manual / Indoor / Outdoor
Electronic Shutter Speed	1 ~ 1/12,000sec
Video Rotation	H-Rev / V-Rev
Analytics	Motion detection
Serial Interface	RS-485(Samsung-T, Pelco-D/P, Panasonic, Bosch, AD, GE, Vicon, Honeywell)
Alarm I/O	MD output 1ea, External D/N 1ea
Alarm Triggers	Analytics
Alarm Events	Alarm output
Coaxial Protocol	ACP(AHD Coax Protocol), TCP(TVI Coax Protocol), CCP(CVI Coax Protocol) CVBS: Pelco-C(Coaxitron)
Video Transmission Distance	500m(5C2V Coaxial Cable) 300m(5C2V Coaxial Cable)
<b>Network</b>	
Resolution	1920x1080
Max. Framerate	30fps / 25fps(60Hz / 50Hz)
<b>Environmental</b>	
Operating Temperature / Humidity	-10°C ~ +55°C(+14°F ~ +131°F) / Less than 90% RH
<b>Electrical</b>	
Input Voltage	24VAC, 12VDC
Power Consumption	Max 3.5W
<b>Mechanical</b>	

Color / Material	Black / Aluminum, Ivory / Plastic
Product dimensions / weight	68.4(W)×59.6(H)×92.7(D)mm(2.69×2.35×3.65"), 186g(0.41 lb)

- The latest product information / specification can be found at [hanwha-security.com](http://hanwha-security.com)
- Design and specifications are subject to change without notice.
- Wisenet is the proprietary brand of Hanwha Techwin, formerly known as Samsung Techwin.

NO	PART NAME	CODE NO.	MATERIAL	QTY	REMARK
----	-----------	----------	----------	-----	--------

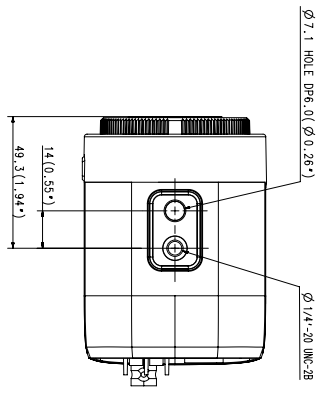
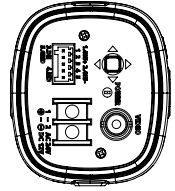
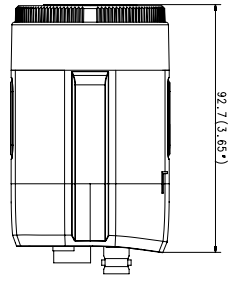
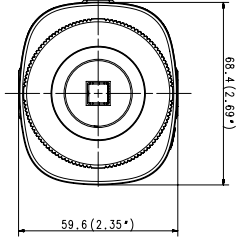
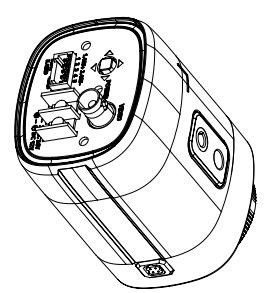
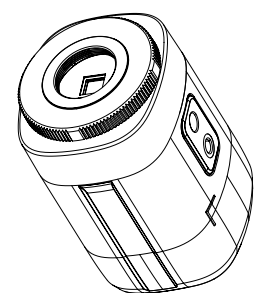
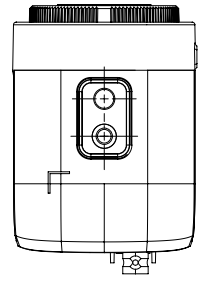

CHANGE

UNIT	MM	DESIGN	H/TW	CHECK	-	APPROVAL	-	PART NAME	-
SCALE	1/1	DATE	17.07.26	DATE	17.07.26	DATE	17.07.26	MODEL NAME	HCB-6000/7000
HANWHA TECHWIN								CODE NO.	057887