

WIRING DIAGRAM

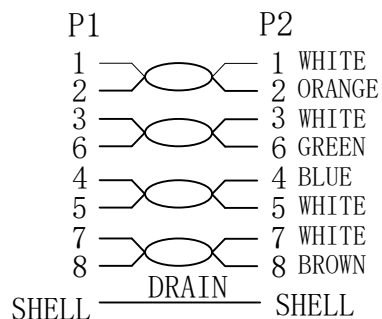

NOTE:

1. 100% OPEN SHORT, MISS WIRE TEST
2. Fluke test
Test limit:ISO 11801 CHANNEL CLASS Ea
3. PRINT WORD:CAT. 6A U/FTP FLAT PVC PATCH CABLE 500 MHz 4PAIRS
ISO11801 & EN50173 & ANSI/TIA568C.2 www.Synergy21.de **CE**
4. ROHS 3.0 AND REACH COMPLIANT

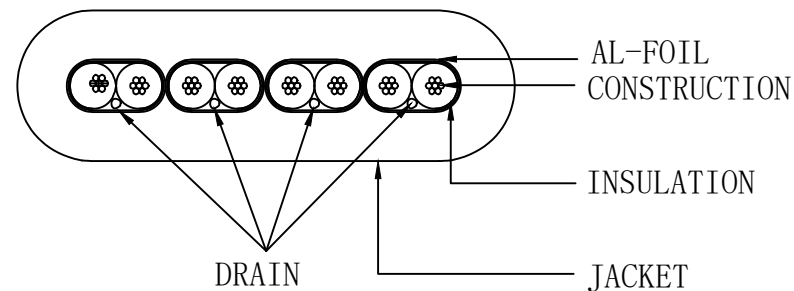

MATERIAL LIST

③	OVER MOLD	PVC COLOUR SEE THE CHART	2	
②	CONNECTOR	RJ45 8P8C shielded Plug, Pin Gold Plated 3U", Transparence blue	2	
①	CABLE	(32AWGBC*1P+AL-FOIL+DRAIN)*4+JACKET:PVC/SEE THE CHART OD:T=2.0±0.2mm W=6.6±0.2MM	1	

NO.	PARTS NAME	SPECIFICATION STANDARD	QT' Y	REMARK
	Hasia	change "ROSH 2.0" to "ROSH 3.0"	2022-02-25	A1
		NEW	2018-02-22	A
BY	CHK	REVISION RECORD MODIFICATION	DATE	REV.

SYNERGY 21					
CUSTOMER		ITEM NO.	See The Chart		
PRODUCT NAME	CAT. 6A U/FTP FLAT PATCH CABLE	manufacture country:	CHINA	UNIT	MM
DRAWNBY	CHECKBY	APPROVE	DATE		
SYNERGY 21	SYNERGY 21	SYNERGY 21	2018-02-22		

Chart:

COLOR:BLACK PANTONE BLACK 3C		
ITEM	LENGTH/mm	PACKING
S216850	150±5	SYNERGY 21 A Bag
S216851	250±10	SYNERGY 21 A Bag
S216852	500±15	SYNERGY 21 A Bag
S216853	1000±20	SYNERGY 21 B Bag
S216854	1500±30	SYNERGY 21 B Bag
S216855	2000±30	SYNERGY 21 B Bag
S216856	3000±50	SYNERGY 21 B Bag
S216857	5000±100	SYNERGY 21 B Bag
S216858	7000±200	SYNERGY 21 B Bag
S216859	10000±200	SYNERGY 21 C Bag
S216860	15000±300	SYNERGY 21 C Bag

COLOR:GREY PANTONE 421C		
ITEM	LENGTH/mm	PACKING
S216861	150±5	SYNERGY 21 A Bag
S216862	250±10	SYNERGY 21 A Bag
S216863	500±15	SYNERGY 21 A Bag
S216864	1000±20	SYNERGY 21 B Bag
S216865	1500±30	SYNERGY 21 B Bag
S216866	2000±30	SYNERGY 21 B Bag
S216867	3000±50	SYNERGY 21 B Bag
S216868	5000±100	SYNERGY 21 B Bag
S216869	7000±200	SYNERGY 21 B Bag
S216870	10000±200	SYNERGY 21 C Bag
S216871	15000±300	SYNERGY 21 C Bag

COLOR:White		
ITEM	LENGTH/mm	PACKING
S216872	150±5	SYNERGY 21 A Bag
S216873	250±10	SYNERGY 21 A Bag
S216874	500±15	SYNERGY 21 A Bag
S216875	1000±20	SYNERGY 21 B Bag
S216876	1500±30	SYNERGY 21 B Bag
S216877	2000±30	SYNERGY 21 B Bag
S216878	3000±50	SYNERGY 21 B Bag
S216879	5000±100	SYNERGY 21 B Bag
S216880	7000±200	SYNERGY 21 B Bag
S216881	10000±200	SYNERGY 21 C Bag
S216882	15000±300	SYNERGY 21 C Bag

SYNERGY 21			
------------	--	--	--

					CUSTOMER		ITEM NO.	See The Chart		
					PRODUCT NAME	CAT. 6A U/FTP FLAT PATCH CABLE	manufacture country:	CHINA	UNTT	MM
		NEW	2018-02-22	A	DRAWNBY	CHECKBY	APPROVE	DATE		
BY	CHK	REVISION RECORD MODIFICATIONS	DATE	REV.	SYNERGY 21	SYNERGY 21	SYNERGY 21	2018-02-22		

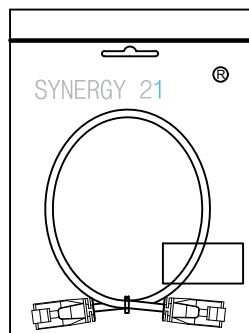

L ≤ 0.5M

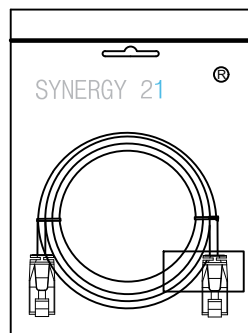

0.5M < L ≤ 7.5

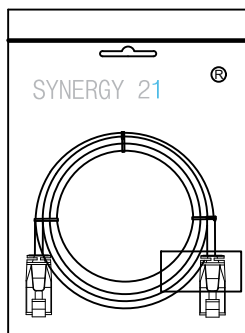

7.5 < L

Labeling example 1

Labeling example 2

Labeling example 3

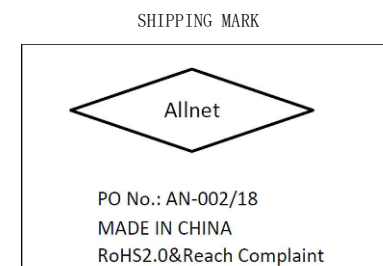
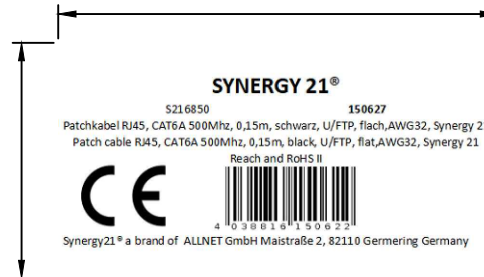
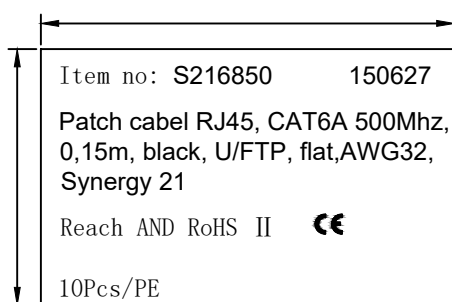
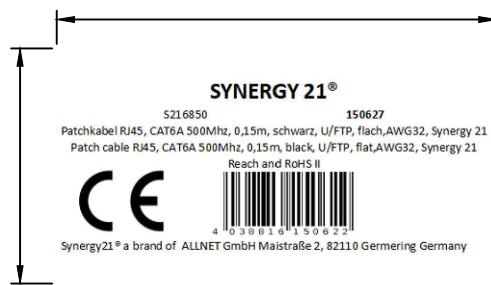

side mark

PO No. :
Item No:
Q' TY:
G. W:
N. W:
Carton No. :
MEAS:

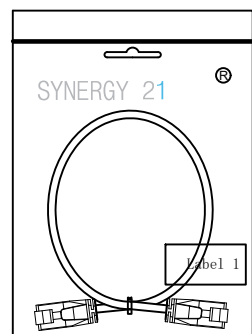

1pcs/SYNERGY 21 Bag+label 1

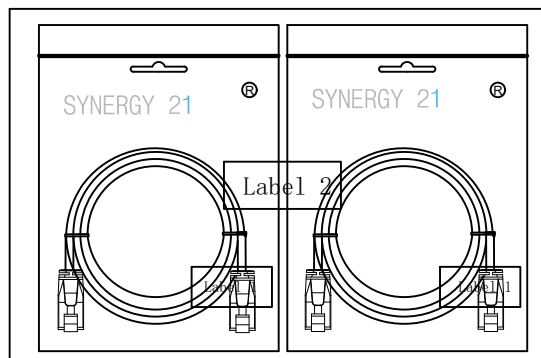

L ≤ 5M: 1pcs/SYNERGY 21 Bag+label 1, 10pcs/pe bag+label 2
5m < L ≤ 10M: 1pcs/SYNERGY 21 Bag+label 1, 5pcs/pe bag+label 2
10m < L: 1pcs/SYNERGY 21 Bag+label 1, without pe bag

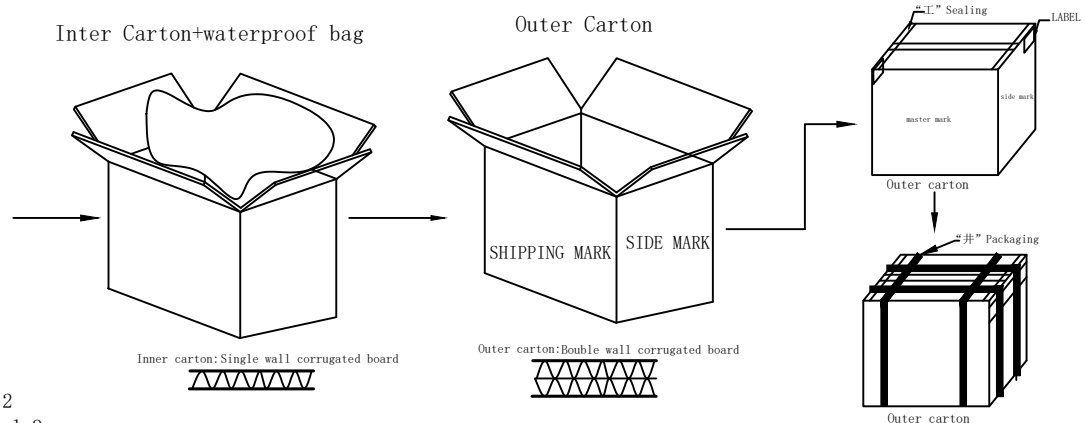

Inner carton: Single wall corrugated board

Outer carton: Double wall corrugated board

SYNERGY 21

						CUSTOMER		ITEM NO.		See The Chart	
						PRODUCT NAME		CHINA		UNIT	
						CAT. 6A U/FTP FLAT PATCH CABLE		manufacture country:		MM	
		NEW		2018-02-22		A		APPROVE		DATE	
BY		CHK		REVISION RECORD MODIFICATIONS		DATE		REV.		2018-02-22	
						DRAWNBY		CHECKBY		SYNERGY 21	
										SYNERGY 21	

SYNERGY 2: Colour pantone 877C
1: Colour pantone 298C
Ⓡ: Colour pantone Black
Bag thickness single side: 0.05mm

CE length and height Must > 5mm