

ITEM NO	COLOUR
S216322	pure white, RAL9010
S216323	pearl white, RAL1013

Materials:

Outlet Housing: ABS /UL94V2

Outlet Base: ABS /UL94V2

Metalic Plate: Al&Zn Alloy /Al&Zn Alloy,

PACKING: 1pcs/PE bag+label 1, 12pcs/box+label 2, 120pcs/ctn+label 1

RoHS 2.0 And REACH Compliant

SYNERGY 21

		UPDATE PACKING TYPE		2018-03-20	A1	PRODUCT NAME	Face plate 1 port	manufacture country	China	UNIT	MM
		NEW		2016-10-11	A	DRAWNBY	CHECKBY	APPOBY	DATE		
BY	CHK	REVISION RECORD MODIFICATIONS		DATE	REV.	SYNERGY 21	SYNERGY 21	SYNERGY 21	2018-03-20		

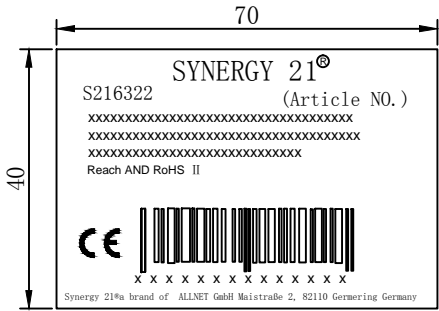

Label 1

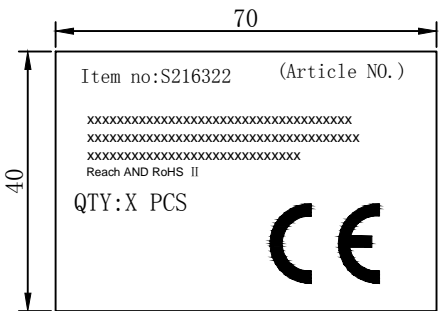

label 2

SHIPPING MARK



PO NO. :
REACH and ROHS 2.0 Compliant
MADE IN CHINA

SIDE MARK

PO NO. :
Item no:
Q' TY:
N. W
G. W
Carton no.
MEAS.

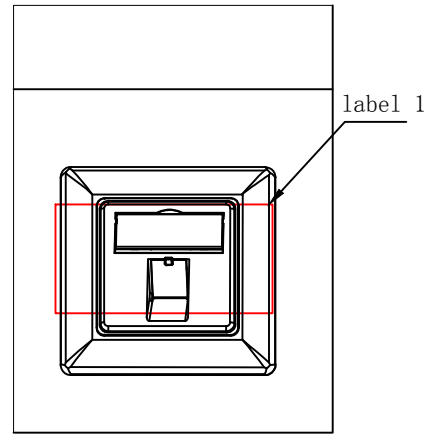

1PCS/PE bag+label1

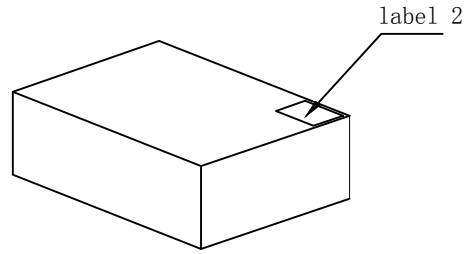
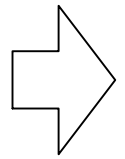

12pcs/box+label2

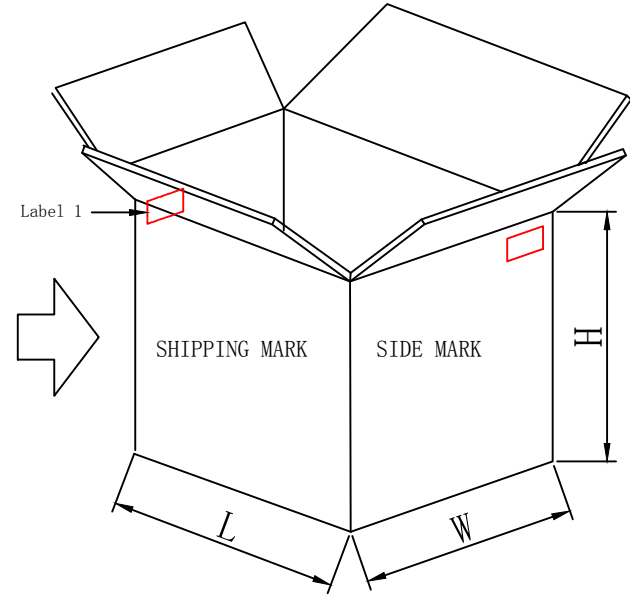
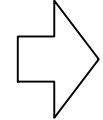

120pcs/ctn+label 1

- NOTE:
- 1.pcs/PE bag+label 1, 12pcs/box+label 2, 120pcs/ctn+label 1
 - “工” type sealing
 - “井” type packaging

SYNERGY 21										
CUSTOMER						ITEM NO.		See The Chart		
PRODUCT NAME		PACKING	manufacture country:		china	UNIT	MM			
DRAWNBY			CHECKBY			APPOBY		DATE		
BY	CHK	REVISION RECORD MODIFICATIONS			DATE	REV.	SYNERGY 21	SYNERGY 21	SYNERGY 21	2018-03-20

		UPDATE PACKING TYPE			2018-03-20	A1
		NEW			2014-09-25	A

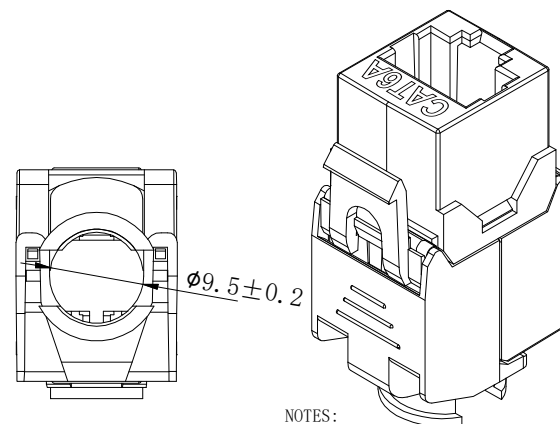
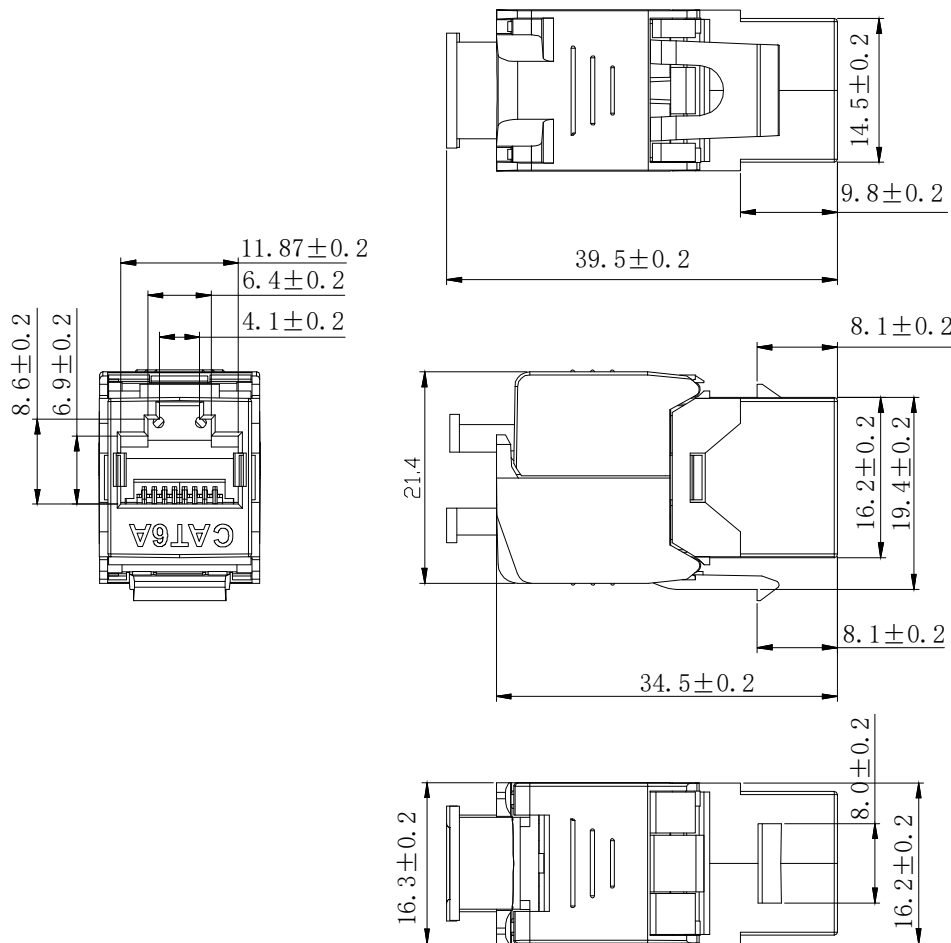

NOTES:

ELECTRICAL:

- 1. Contact Resistance : 20MΩ MAX
- 2. Insulation Resistance : 500MΩ MIN @ 500V DC
- 3. Withstand Voltage : DC 1000V AC 700V RMS 60Hz, 1MIN
- 4. Compliance with Class EA up to 500 MHz to ISO/IEC 11801 Ed. 2.2:2011-06
DIN EN 50173-1:2011-09
TIA/EIA-568-C.2 (2009-08)
IEC 60603-7 Ed.1 (12/2008)

ENVIRONMENTAL:

- 1. Storage temperature : -40°C to +70°C
- 2. Operation temperature : -10°C to +60°C

MECHANICAL

- 1. SHIELD MATERIAL: ZINC ALLOY
 - 2. IDC MATERIAL: PC TERMINAL:PHOSPHOR BRONZE, TIN PLATING
 - 3. RJ45 Contact Life: 750 Times Min
 - 4. Plug inforce:<30N
 - 5. Solid cable:1/22AWG(0.65MM)-1/26AWG(0.40MM) ID:1.05MM-1.5MM
 - 6. Cable OD: 5.0mm-8.5mm
 - 7. PoE per IEEE 802.3af, PoE/per IEEE 802.3at, PoE+/per IEEE 802.3bt PoE++
 - 8. 360° Shield connection
 - 9. Fluke Test: Permanent link ISO11801 (PL2) Class Ea
- RoHS 3.0 and REACH Compliant
- Accessories:
Instruction Sheet *1pc/inner box
Cable Tie(75X1.9mm) *1Pc
Copper foil *1Pc
SinglePack: 1pc/PE bag+label; SubPack: 25pcs/box+label; Carton +labelx2;

MATERIAL LIST:

⑦	MODULAR COVER	PC with T568A/B label	1	
⑥	RJ 45 JACK INSERT	8P8C PHOSPHOR BRONZE GOLD PLATED	8	
⑤	PCB	FR-4 1.6mm UL 94V0	1	
④	IDC BODY	PC White	1	
③	IDC PIN	PHOSPHOR BRONZE & TINNED	8	
②	LABEL COLOR CODE	T568A/B	2	
①	IDC TERMINAL	FOR 22-26AWG CABLE	1	
NO.	PARTS NAME	SPECIFICATION STANDARD	QT' Y	REMARK
		NEW	2022-10-28	A
BY	CHK	REVISION RECORD MODIFICATIONS	DATE	REV.

SYNERGY21

CUSTOMER	AN	ITEM NO.	S216318V2		
PRODUCT NAME	CAT. 6A/ClassEA STP KEYSTONE JACK W:16.3MM	manufacture country:	CHINA	UNIT	MM
DRAWNBY	CHECKBY	APPOBY	DATE		
SYNERGY21	SYNERGY21	SYNERGY21	2022-10-28		

Montageanweisung

Cat.6A UTP/STP Keystone jack

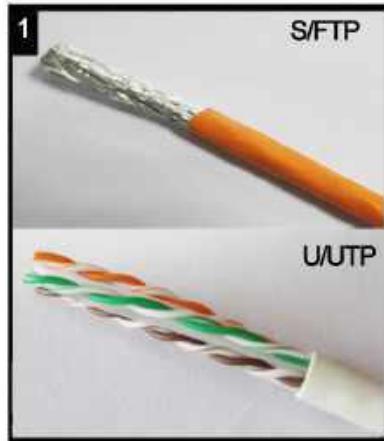

Außenmantel des Verlegekabels ca.4 cm abnehmen und Gesamtschirmung nach hinten ziehen.
Strip off approx. 4 cm of the cable jacket and fold total shield back over it.

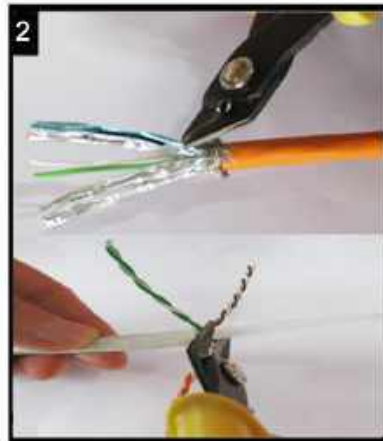

Paarfolie entfernen.
Remove pair shielding.



Der Kabelsortierer verfügt über beide Farbcodes(568A/B).Wählen Sie den entsprechenden Farbcode.
Please choose colour code 568A or B according your application.

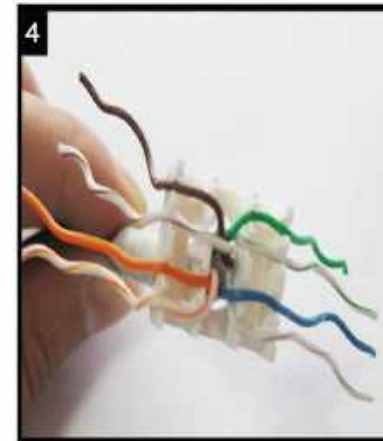

Kabel einführen und die einzelnen Adern nach der von Ihnen gewählten Belegungsvariante in den Kabelsortierer einführen.
Insert the cable into the termination cap and fan out all four twisted pairs following the colour code printed on the termination cap. Make sure that all conductors are in the proper slot.

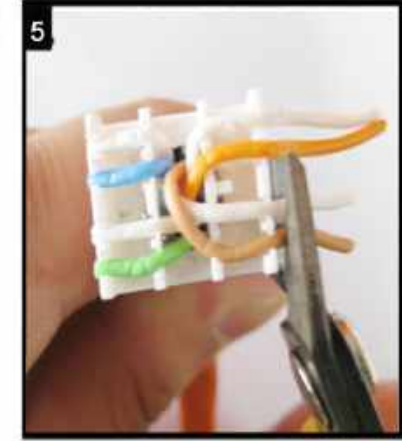

Überstehende Adern abschneiden.
Trim the ends of the conductors.

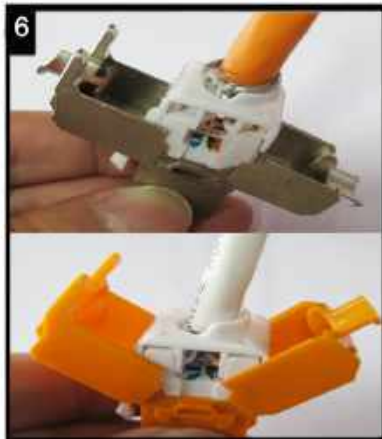

Den Sortierer in Pfeilrichtung in das Modul einsetzen.Bitte Pfeilrichtung beachten!
Install the termination cap in direction of arrow into the Keystone Jack.

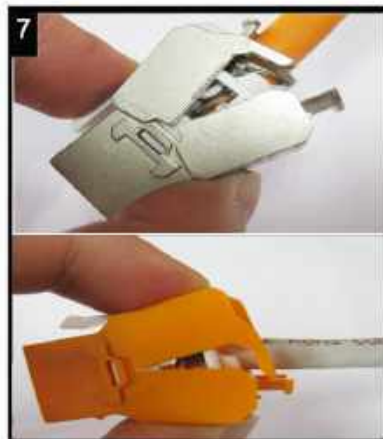

Die Montageklappen schließen -mit diesem Vorgang wird das Modul kontaktiert.
Press both covers of the Keystone Jack to contact the cable.

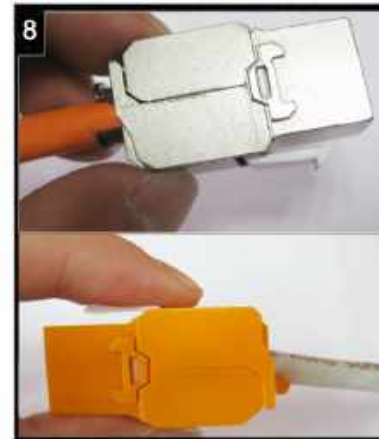

Ggf. die Anverterung nochmals kontrollieren und schließen.
Control the operation and close the Keystone Jack finally.

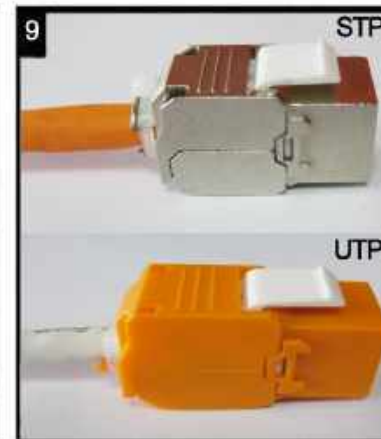

Das Modul mit dem Kabelbinder zugentasten und die Schirmschelle fixieren.
Use cable tie for strain relief and to fix the shielding clamp.

Oder mit kabel binder die zugentlastung zu fixieren.
Or cable tie to fix the strain relief.